







VP1012 street light - RWS Natura Edition

Standard:	230 V 50 Hz	4000K CRI >70 McAdam5	IP66	RAL 7036	3 x 2,5 mm ²	-O					
Options:		K CRI McAdam	DALI	PROG	ZHAGA	CLO					

Use for: Street and highway lighting.

Installation: Pole or arm.

Colour control: The luminaire has adjustable light colour. This luminaire can change during night to most suitable colour temperature for the nature. User can control colour temperature and power level schedules with compatible Zhaga controller node.

Triple colour system with White/Red/Amber LEDs can eliminate the emission of blue light during night time. Humans have evolved in a world with solar-derived light spectra and an absence of light during the night. Flame lamps and fires emit little blue light. The studies strongly suggest that light of non-natural spectrum or timing may have profound and unintended effects on many parameters central to human physiology and to the nature in general.

Technical Properties

VP1012	150 RWS Natura (4000K/Amber/Red)	
Input power W / channel	0, 15 - 150	
Useful quantity of light lm / channel	0, 2 000 - 20 000	
Power ratio	According to standard EN 61000-3-2	
Operating temperature °C	-40...+45 ⁽¹⁾	
Weight kg	~14	
Materials	Painted (stoved) aluminium casting and arm bracket, hardened 5 mm glass with special coating.	
Fastening	Ø 60 mm or Ø 76 mm pole or shaft	
Tilt angle	0°, ± 5°, ± 10°, ± 15°	
LED lumen maintenance	Compensated with a patented method that is based on the actualized power usage.	Typically less than 10%/100 000 h
Life span L ₈₀ B ₁₀ C ₁₀ T _a 25 °C	> 100 000 h	100 000 h

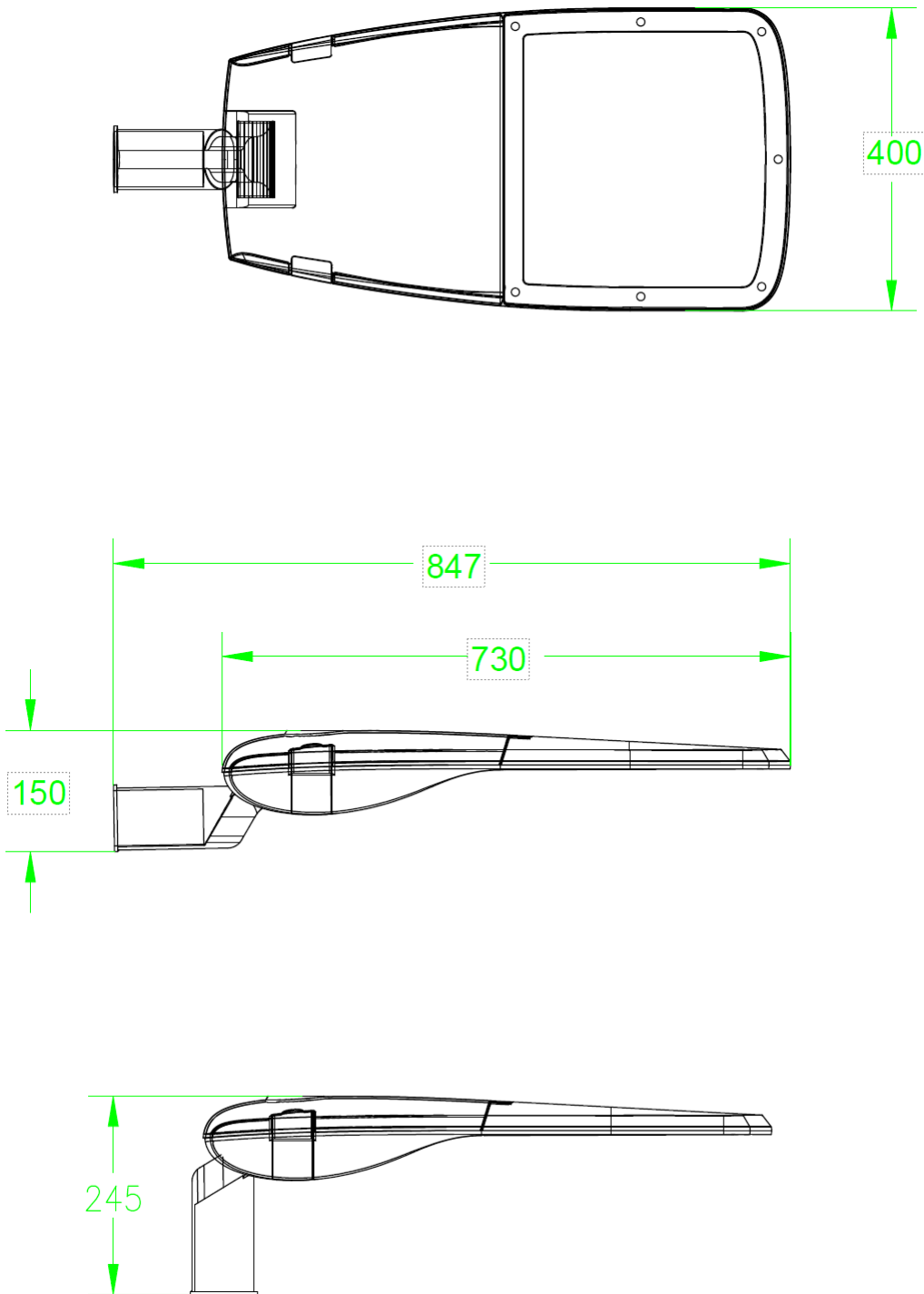

Lumous lighting Oy
Oulu, Finland

For more information visit www.lumouslighting.com
or call +358 29 310 310

Subject to change without prior notice.