

TECHNICAL MANUAL

KÖSTER ROOFING

MEMBRANES



Content

1. KÖSTER BAUCHEMIE AG – Manufacturer of Thermoplastic Roofing and Waterproofing Membranes	4
1.1. General	4
1.2. Products	4
1.2.1. General	4
1.2.2. KÖSTER TPO	5
1.2.3. KÖSTER TPO F / F (FR)	5
1.2.4. KÖSTER TPO SK (FR)	5
1.2.5. KÖSTER ECB	5
1.2.6. KÖSTER ECB F.....	5
1.2.7. Product features	6
1.3. Quality control.....	6
1.4. Environmental protection and ecology.....	6
1.5. KÖSTER: Your reliable partner in construction	6
1.6. Warranties	6
2. The flat roof	8
2.1. General	8
2.2. Standards and guidelines	8
2.3. Definition of flat roof	9
2.4. Stresses	9
2.5. Usage	9
2.5.1. Unused flat roofs	9
2.5.2. Flat roofs in use	9
2.6. Design types	10
2.6.1. Ventilated roof (cold roof).....	10
2.6.2. Non-aerated roof (warm roof)	11
2.6.2.1. Normal roof	11
2.6.2.2. Inverted roof	11
2.6.2.3. Double / built-up flat roof or combination roof	12
3. Planning and design of flat roofs	13
3.1. Gradient	13
3.2. Substructure.....	13
3.2.1. Concrete	13
3.2.2. Wood materials	13
3.2.3. Steel trapezoidal profiles	13
3.3. Vapor barriers	13
3.4. Insulation	14
3.5. Separating layers / protective layers.....	14
3.6. Waterproofing	14
3.6.1. Application / Installation method.....	15
3.6.2. Overlap	17
3.6.3. End butt joints / cross butt joints.....	18
3.6.4. Weld seam width	18
3.7. Safety measures	18
3.7.1. Securing against horizontal forces.....	18
3.7.2. Protection against wind suction forces.....	18
3.7.2.1. Mechanical fastening	18
3.7.2.2. Adhesion	19
3.7.2.2.1. Full-surface adhesion	19
3.7.2.2.2. Stripe adhesion	19
3.7.2.2.3. Self-adhesive installation	20
3.7.3. Securing with ballast	21
3.7.3.1. Ballasts	21
3.7.3.2. Green roofs	21
3.7.3.2.1. Extensive green roof	22
3.7.3.2.2. Intensive green roof.....	22
3.8. Detailing	23
3.8.1. General planning principles	23
3.8.2. Junctions and transitions	23
3.8.2.1. Junctions to rising components	23
3.8.2.1.1. Example wall junction up to 50 cm junction height.....	24
3.8.2.1.2. Example wall junction over 50 cm junction height.....	25
3.8.2.1.3. Junction to row of windows and skylight dome	26
3.8.2.2. Junction to doors	27
3.8.2.3. Roof edge transitions	28
3.8.2.4. Junctions to eaves.....	30
3.8.2.5. Clamping constructions	31
3.8.2.5.1. Clamping profiles	31
3.8.2.5.2. Clamping rails	32
3.8.2.5.3. Loose / fixed flange constructions	33
3.8.3. Junctions to penetrations	36
3.8.3.1. Round penerations	36
3.8.3.2. Attachment points, supports, etc.	36
3.8.3.3. Right-angled penetrations	37
3.8.4. Drainage	38
3.8.4.1. General.....	38

3.8.4.2. Storm drains	38
3.8.4.3. Emergency drains/spillways	41
3.8.4.4. Roof gutters	41
3.8.5. Movement joints.....	42
3.8.5.1. Joint type I	42
3.8.5.2. Joint type II	43
3.8.6. Other	45
4. Terraces / Balconies.....	45
5. Earth-covered components	45
6. Care and Maintenance.....	45
7. Renovations	46
7.1. General.....	46
7.2. Renovation without removal of the old roof.....	46
7.2.1. Old bitumen roof.....	46
7.2.2. Old plastic roofs.....	46
7.3. Renovation with removal of the waterproofing layers	47
7.4. Renovation with additional insulation	47
7.5. Complete renovation	47
8. Information for working with KÖSTER TPO/ECB	47
8.1. Tools	47
8.2. Welding	47
8.3. Weathered TPO and ECB roofing membranes	48
8.4. General comment	48
9. Accessories	48
10. Service forms	49
10.1. Wind zone map of Germany.....	49
10.2. Site categories.....	50
10.3. Wind load calculations	51
10.4. Flat roof planning checklist.....	52
10.5. Flat roof renovation checklist.....	53
11. Tender documents	54
12. Legal Notice	54

1. KÖSTER BAUCHEMIE AG - Manufacturer of thermoplastic roofing and waterproofing membranes

1.1. General

KÖSTER BAUCHEMIE AG has been developing and producing products for waterproofing buildings since 1982.

Due to its accumulated experience in production and processing along with the high quality of its products, KÖSTER BAUCHEMIE AG roofing and waterproofing membranes can be found on roofs all over the world.

1.2. Products

1.2.1. General

In the plant in Aurich, three extruder lines produce high-quality roofing membranes made of the materials TPO / FPO (thermoplastic or flexible polyolefins) and ECB (ethylene copolymer bitumen), certified in accordance with EN 13956 CE.

The main component of KÖSTER waterproofing membranes is polyethylene, one of the oldest and most commonly used polymers. KÖSTER roofing and waterproofing membranes are free of volatile plasticisers and remain flexible throughout their entire service life.

The structure of both product lines is identical: they are made of the same material on the top and bottom and contain a centrally inserted reinforcement glass mesh.

KÖSTER F (Fleece) membranes are additionally laminated with polyester fleece on the bottom.

KÖSTER SK (Self-adhesive) is equipped with a special polyester fleece with a self-adhesive layer as lamination.

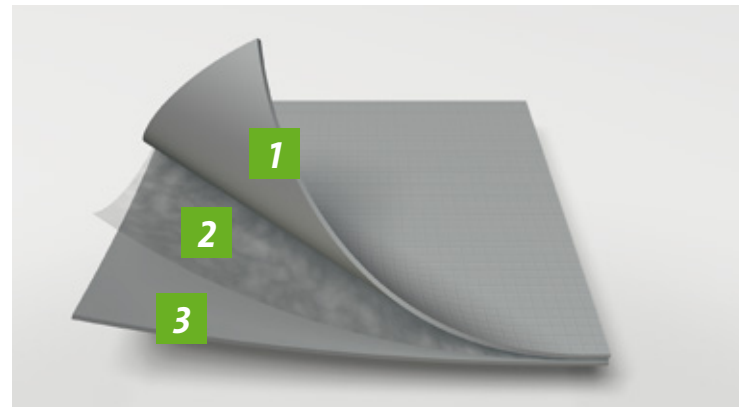

KÖSTER TPO: 1) TPO; 2) Glass mesh; 3) TPO

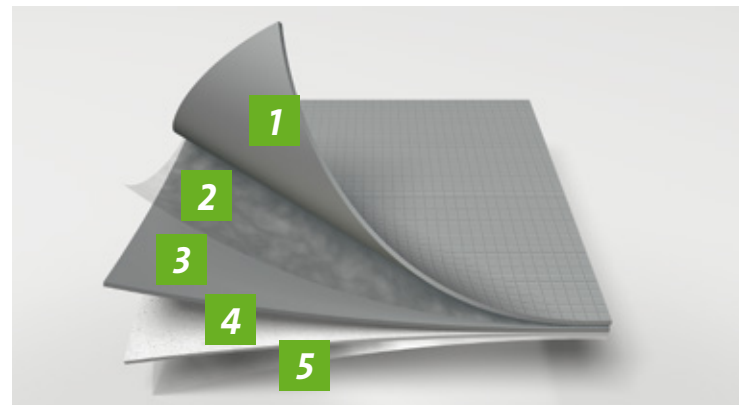

KÖSTER TPO SK: 1) TPO; 2) Glass mesh; 3) TPO; 4) Special polyester fleece with self-adhesive layer; 5) Protective film

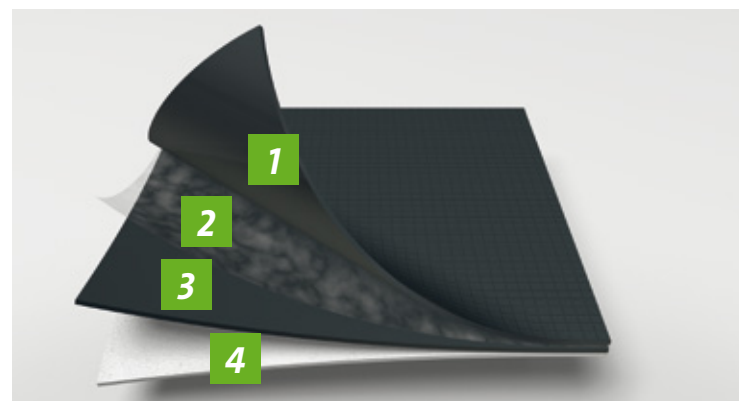

KÖSTER ECB F: 1) ECB; 2) Glass mesh; 3) ECB; 4) Polyester fleece

1.2.2. KÖSTER TPO

	KÖSTER TPO 1.5	KÖSTER TPO 1.8	KÖSTER TPO 2.0
Thickness	1.5 mm	1.8 mm	2.0 mm
Width	2,10 m* / 1.50 m / 1.05 m / 0.75 m / 0.525 m / 0.35 m / 0.25 m		
Roll length	20 m		
Color	Light grey, white (SRI 106), slate grey; special colors on request		

* not available for 1.5 mm thickness

1.2.3. KÖSTER TPO F / F (FR)

	KÖSTER TPO 2.0 F	KÖSTER TPO 2.0 F (FR)
	With polyester fleece lamination on the bottom	With polyester fleece lamination on the bottom and increased fire protection
Effective thickness	2.0 mm	2.0 mm
Total thickness	2.8 mm	2.8 mm
Width	1.50 m / 1.05 m / 0.525 m	
Roll Length	20 m	
Color	Light grey, white (SRI 106); special colors on request	Light grey; special colors on request

1.2.4. KÖSTER TPO SK (FR)

	KÖSTER TPO 1.5 SK (FR)	KÖSTER TPO 2.0 SK (FR)
	With special fleece lamination on the bottom, with self-adhesive layer and increased fire protection	
Effective thickness	1.5 mm	2.0 mm
Total thickness	1.8 mm	2.3 mm
Width	1.05 m / 0.525 m	1.05 m / 0.525 m
Roll Length	20 m	20 m
Color	Light grey; special colors on request	

1.2.5. KÖSTER ECB

	KÖSTER ECB 2.0
Thickness	2.0 mm
Width	2.10 m / 1.50 m / 1.05 m / 0.75 m / 0.525 m / 0.35 m / 0.25 m
Roll length	20 m
Color	Black

1.2.6. KÖSTER ECB F

	KÖSTER ECB 2.0 F
Thickness	With polyester fleece lamination on the bottom
Width	2.0 mm
Roll length	2.10 m / 1.50 m / 1.05 m / 0.525 m
Color	20 m
Farbe	Black

1.2.7. Product features

KÖSTER roofing and waterproofing membranes have the following features:

- Same material quality on the top and bottom layers
- Can be welded homogeneously with hot air
- Temperature and weather-resistant
- Ageing resistant and rot-proof
- Negative temperatures flexibility ($\leq -50\text{ °C}$)
- UV-resistant
- Resistant to root penetration (FLL cert.)
- Bitumen compatible
- Polystyrene compatible
- Insulation neutral
- Resistant to normal mechanical stresses
- Resistant to microorganisms and adhered coatings
- Environmentally friendly (EPD environmental declarations, DGNB/German Sustainable Building Council and LEED classification)
- Harmless to health, water, soil, animals and plants
- Free of volatile plasticisers
- Chlorine-free
- Recyclable

Common roof structures with KÖSTER roofing and waterproofing membranes are classified in accordance with EN 13501-5 (fire from outside).

1.3. Quality control

Waterproofing of buildings is an area in which high-quality materials and processing may not only make a difference, but actually save time and money. KÖSTER BAUCHEMIE AG supplies materials of the highest quality, durability and longevity. KÖSTER BAUCHEMIE AG does not compromise on quality and firmly believes in a long-term and strong relationship with its customers. This philosophy applies to all of the company's divisions, from research and development through production and sales. This is also affirmed by a QM system that is certified in accordance with DIN EN ISO 9001:2015.

KÖSTER roofing and waterproofing membranes have CE label in accordance with EN 13956 System 2+ and EN 13967. The quality of the products is then regularly checked internally and guaranteed by regular monitoring of production and quality assurance by an external testing institute.

1.4. Environmental protection and ecology

KÖSTER BAUCHEMIE AG is committed to the protection and preservation of the environment, combining the use of state-of-the-art raw materials and production technologies in conjunction with continuous research and development. Today, this means that most materials are not only solvent-free, but also designed for minimal environmental impact and maximum protection for contractors. As a member of the German Chemical Industry Association, KÖSTER BAUCHEMIE AG is also part of the Responsible Care worldwide initiative, which is committed to responsible and sustainable action within the industry in the areas of health protection and environmental protection. In addition, KÖSTER BAUCHEMIE AG is a member of the Institute for Construction and the Environment, whose members are committed to sustainable construction. The basis for this is transparent disclosure of all relevant product information, including life cycle assessment data.

KÖSTER roofing and waterproofing membranes have product declarations in accordance with the DGNB and LEED system and environmental product declarations in accordance with ISO 14025 and EN 15804 (EPD). All manufacturer-relevant criteria for materials and products are evaluated in order to qualify sustainable and low-emission building materials.

1.5. KÖSTER: Your reliable partner in construction

KÖSTER BAUCHEMIE AG has built a reputation as a reliable partner in the construction industry over many years thanks to its expertise in high-quality and durable waterproofing. Solving waterproofing problems requires knowledge and experience. That is why KÖSTER provides customers and partners with their experienced experts, who provide help in mastering challenges on site and always find a safe, economical solution. In addition, KÖSTER BAUCHEMIE AG offers numerous training courses and seminars for architects and contractors to guarantee successful use of its products.

1.6. Warranties

KÖSTER stands behind its products and customers. That's why KÖSTER BAUCHEMIE AG offers an extensive warranty program for TPO membranes: Premium and Premium Plus. With the Premium warranty level, the roof is insured

for a period of 10 to 20 years, depending on the membrane thickness.

There is coverage for both material and wage reimbursement for installation of the membrane and for the costs of replacing the damaged components from the roofing layer package (for example, soaked-through insulation). With the Premium Plus warranty level, the coverage goes one step further: reimbursement for consequential damage to general assets is covered by extended product liability insurance from Allianz AG. This enables choosing the appropriate warranty for each roof.

Advantages of warranty insurance with KÖSTER:

- The KÖSTER warranty can cover all KÖSTER roofing membrane products from the price list valid upon concluding the warranty.
- All member companies of the Central Association of the Roofing Trade (ZVDH) have been granted a material warranty extended to six years. Details can be found through ZVDH.
- The proven quality of KÖSTER TPO roofing and waterproofing membranes is the reason for the unusual commitment of Allianz-AG to extend the product liability up to 25 years.
- After completing a construction project with KÖSTER products, KÖSTER BAUCHEMIE AG provides the installer with a project-related warranty certificate.
- With this warranty, KÖSTER offers much more than the legal minimum for a product warranty.



2. The flat roof

2.1. General

Flat and sloping roofs have existed for centuries. Modern architecture, functional industrial buildings and a variety of new materials have significantly increased the proportion of flat roofs in recent decades.

Cold, heat, rain, hail and snow, extreme wind loads, UV and infrared rays and many different chemicals will affect a roof. There are all also movements or tensions stemming from the building itself. A roof must be capable of continuously withstanding many loads. At the same time, residents or users place a wide variety of demands on their roofs. They should be architecturally sophisticated, roof terraces should offer space to feel good and relax, solar collectors and solar modules should produce energy and be securely fastened on roofs. Many other installations and superstructures, such as ventilation shafts, transmission masts or chimneys can also be found on roofs. The following requirements are in focus for selection of the roof structure:

- Safety
- Durability
- Cost effectiveness
- Lowest possible environmental impact
- Low weight
- Easy to work with
- Low maintenance requirements

If the roof waterproofing is carefully planned and executed, the building will be well protected for decades.

High-quality materials in connection with qualified and standard-compliant waterproofing work guarantee a long service life for flat roofs.

This manual is intended to assist in the creation of professional flat roof waterproofing.

2.2. Standards and guidelines

In order to guarantee durable and safe implementation of roof waterproofing work, standards and guidelines have been established and continuously developed over time.

Among the most important are:

For materials:

- **EN 13956** waterproofing membranes – Plastic and elastomer membranes for roof waterproofing – Definitions and properties
- **EN 13967** waterproofing membranes – Plastic and elastomer membranes for waterproofing buildings – Definitions and properties
- **SPEC 20.000–201** Application standard for waterproofing membranes in accordance with European product standards for use in roof waterproofing
- **SPEC 20.000–202** Application standard for waterproofing membranes in accordance with European product standards for use in waterproofing systems
- **EN 13501** Fire behaviour of substances

For implementation:

- Installation Instructions of KÖSTER BAUCHEMIE AG
- **DIN 18531** Roof waterproofing
- **DIN 18195 + DIN 18531** ff. Building waterproofing
- Flat roof guideline of the German roofing trade
- Specialist regulations for metal work in the roofing trade
- Energy saving regulations - ENEC
- **EN 1991-1-4** Wind loads
- **ETAG 006** Mechanically attached roof systems
- **FLL Guideline** Root resistance of waterproofing
- **VOB** Contract award regulations in the construction trade
- **CEN/TS 1187** Test procedures for external fire exposure
- Construction regulation list A, part 3, no. 2.8
- **EN 1253** Drains for buildings
- **EN 12056** Part 3 - Gravity drainage inside buildings

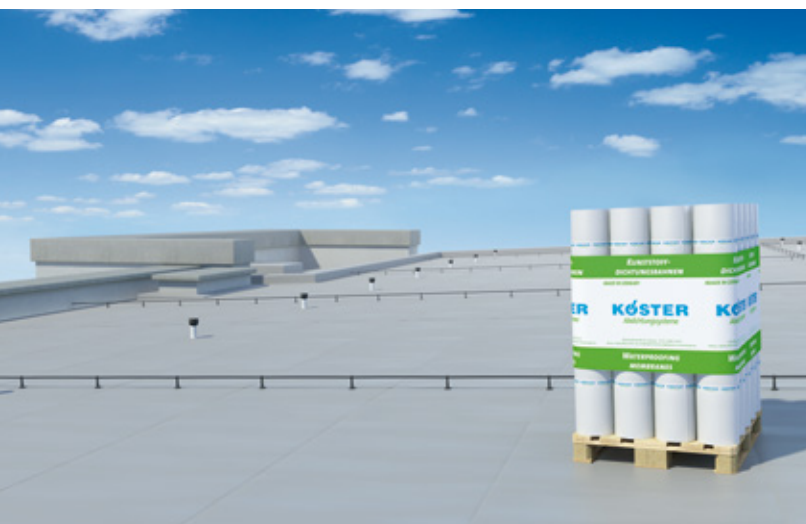

- **DIN 1986-100** Drainage systems for buildings and land plots
- **EN 13162** Thermal insulation building materials made from mineral wool
- **EN 13163** Thermal insulation building materials made from expanded polystyrene EPS
- Industrial construction guidelines
- **DIN 18234** Structural fire protection of large-area roofs
- KTW- German Federal Environment Agency Guidelines
- DVGW/German Technical and Scientific Association for Gas and Water rules and regulations

Furthermore, there are a large number of country-specific regulations which must be observed and complied with when carrying out roof waterproofing work.

2.3. Definition of flat roof

A flat roof is a roof with a low roof pitch between 2° and 10°. Due to the low roof pitch, the water flows off slowly and puddles can form due to unevenness or similar conditions. Therefore, a flat roof must be waterproofed.

Roofs with roof pitches between 10° and 20° are referred to as flat pitched roofs.

Roofs with more than a 20° roof pitch are called steep roofs.

2.4. Stresses

Environmental influences such as weathering, emissions, humidity, wind and snow loads, dirt and dust deposits, changing temperatures, atmospheric precipitation, UV radiation, oxygen, ozone and mechanical stress due to using roof surfaces can have a negative effect on the service life of the building materials and the quality of the roof construction.

2.5. Usage

2.5.1. Unused flat roofs

Unused flat roofs are not intended for permanent residents. They may only be entered for maintenance or repair purposes. This also includes extensive green roof areas.

2.5.2. Flat roofs in use

Flat roofs that are being used are understood to be roofs that are used as, for example, terraces, balconies, recessed balconies, access balconies,

roofs with intensive green roofs, and roofs with solar systems.

Roofs in use also include earth-covered ceiling surfaces.

Trafficable flat roofs

Due to the weight of the vehicles that are allowed to drive on the roof, special requirements are placed on the substrate and the thermal insulation. On parking decks, for example, foam glass should be used as thermal insulation because it is extremely pressure-resistant. Protection of the waterproofing under the wear layer must be ensured via suitable measures, such as by using geotextiles or other suitable protective and separating layers.

Green roofs

A green roof is alive. The roots of the trees and shrubs planted in the humus layer can penetrate the waterproofing membrane layer, causing leakages. This makes special root protection measures necessary. KÖSTER TPO membranes are root-resistant and tested according to the FLL method. This eliminates the need for an additional root protection layer in the green roof structure.



2.6. Design types

2.6.1. Ventilated roof (cold roof)

An aerated roof consists of a two-layer flat roof structure (upper and lower shell). The height of the aeration level, as longitudinal and transverse aeration, should be at least 15 cm. Usually an elevated wooden construction with formwork is applied to a reinforced concrete or wooden beam ceiling. Lower-cost fibre insulation materials can be used on the lower shell for thermal insulation.

The great advantage of a cold roof is that this construction method is structurally safe, provided that the aeration level is perfectly connected to the outside air and the amount of moisture diffused in is not too large. To ensure this, a vapour barrier can be installed under the thermal insulation (PE with a low s_d value). A vapour seal will not be required in that case.

If the upper shell is inclined relative toward the lower shell, an additional chimney effect is created, which ensures improved aeration of the double-shell flat roof structure. If necessary, the required aeration cross-section can be reduced in this regard.

The aeration openings must be protected against the ingress of birds, vermin, etc. with sieves or grilles.

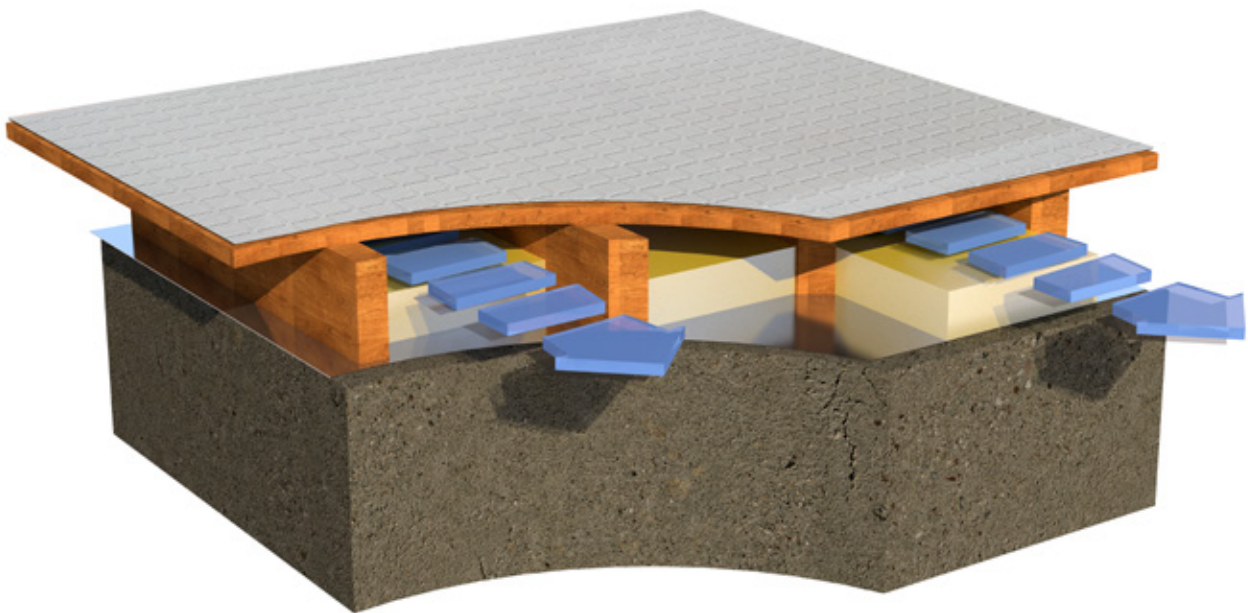

2.6.2. Non-aerated roof (warm roof)

2.6.2.1. Normal roof

In the case of a normal, non-aerated roof, the waterproofing is directly above the insulation. A vapour seal must be installed on the supporting shell under the insulation. The design of the vapour seal and determination of the connection details for the structure's functional layers must be carried out by the planner.

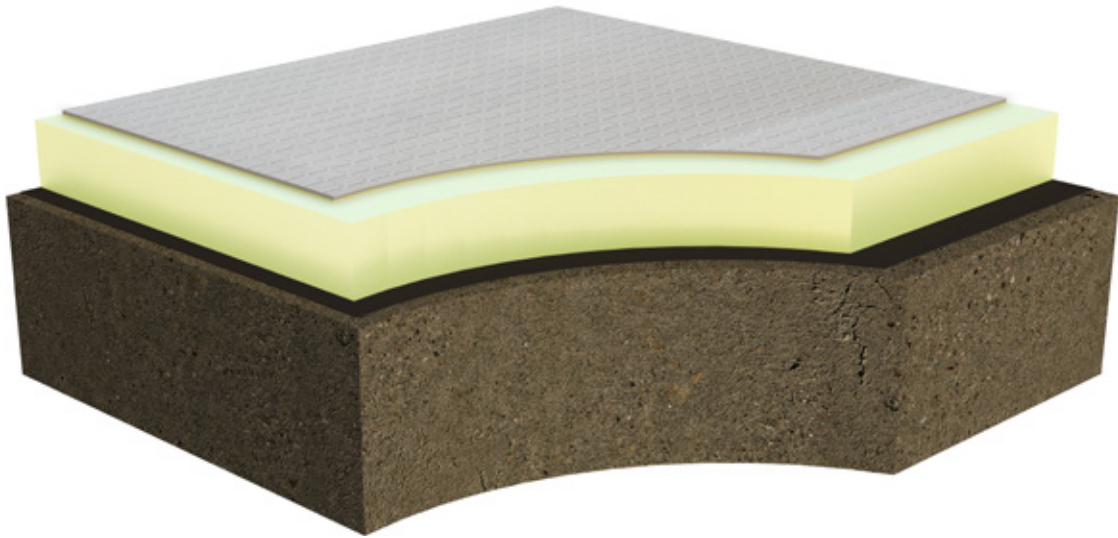

2.6.2.2. Inverted roof

The difference to construction of the standard roof lies in the fact that the waterproofing on the base layer is under weatherproof and environmentally resistant insulation, which is secured by suitable ballast. A vapor seal is not required.

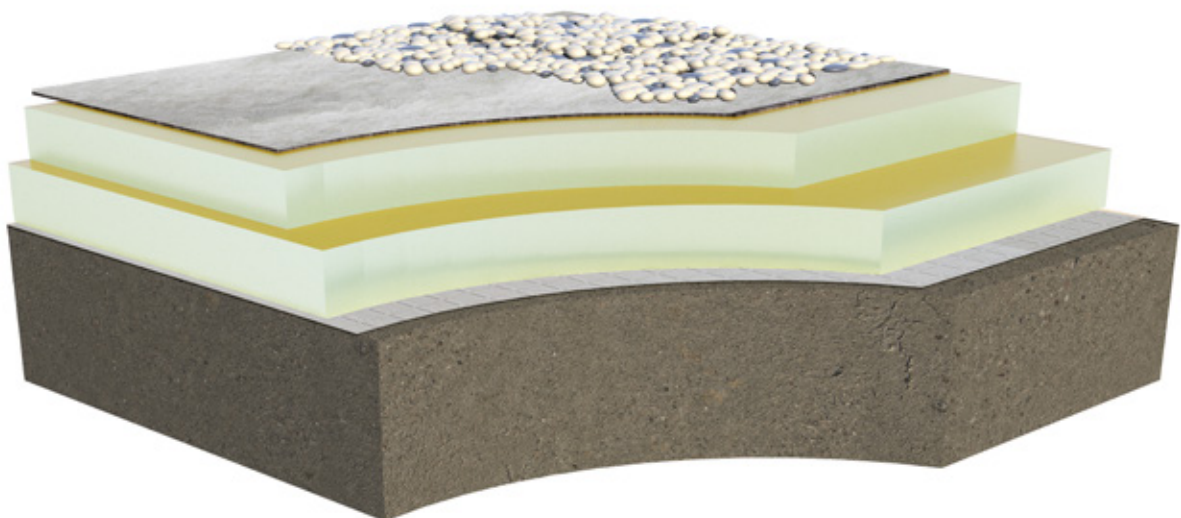

2.6.2.3. Double / built-up flat roof or combination roof

The double or built-up flat roof is a flat roof construction whereby the roof waterproofing is placed between two thermal insulation layers. The upper insulation layer must be weatherproof and environmentally resistant. As with the inverted roof, it must be mechanically fastened or protected from wind suction with sufficient ballast. It is covered with trickle protection / filter fleece to prevent small dust and dirt particles from seeping in.

The roof construction serves in particular to improve the insulating capacity of normal, single-shell flat roofs. For this reason, it is also referred to as a „combined inverted roof“. The roof thus represents a combination of normal and inverted roofs.

Since the roof waterproofing is „packed“ between two insulation layers, it is subject to less thermal stress. When renovating a normal roof in this way, it must always be ensured beforehand that the „old“ roof has its full structural function and that there are no previous damages to the roof structure.

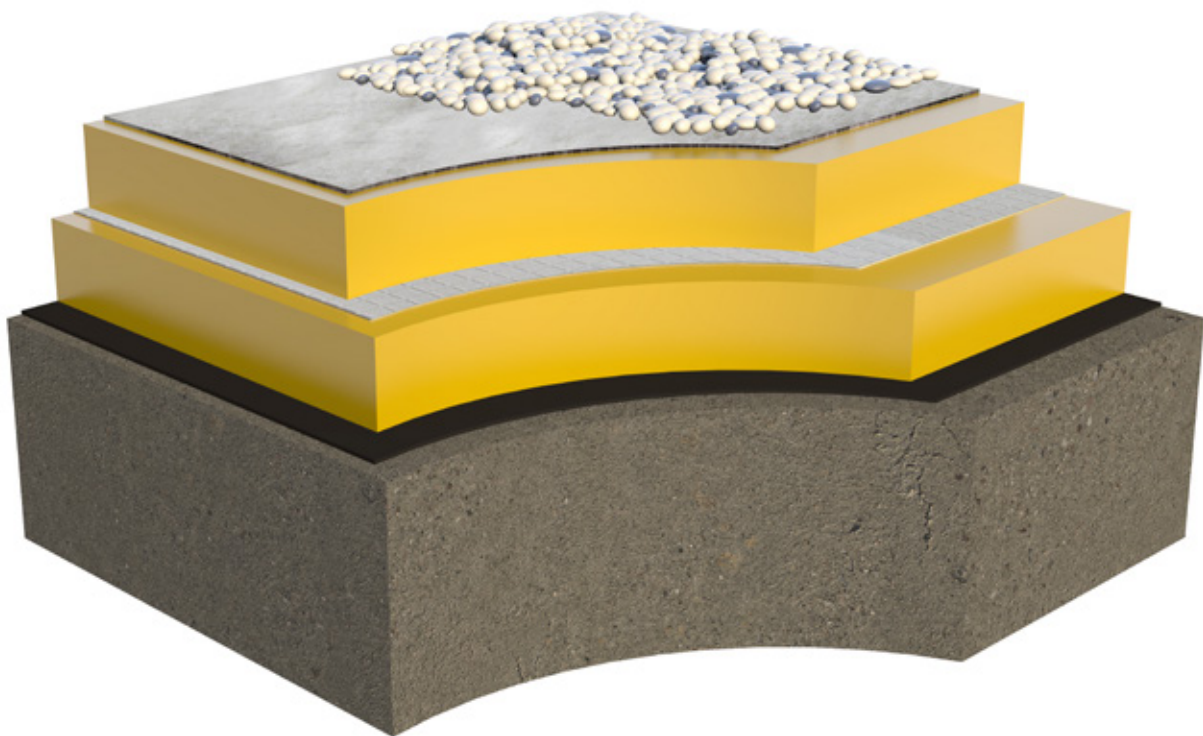

3. Planning and design of flat roofs

3.1. Gradient

A gradient of at least 2 % (approx. 1.2°) should be planned for diverting surface water. The gradient can be created via the substructure, e.g. sloping screed, wooden constructions, tapered segments for wooden formwork or insulating materials in wedge form. The drainage elements must be installed at the lowest points of the gradient.

Puddles can also form on roof pitches of up to 5 % due to permissible tolerances, deflections, thicknesses of the materials and overlaps.

In exceptional cases, a gradient-free design is permissible, e.g. for renovations with already provided drainage, for low connection heights to doors, legal building requirements that do not permit a gradient, or intensive greening and earth-covered areas with mat irrigation.

3.2. Substructure

Substructures close off the building upwards and are flat supports for receiving the roof structure. These must be continuous, clean and free of unevenness. They can consist of concrete, precast concrete parts, wood materials, trapezoidal sheets or other suitable materials. If possible, it is recommended to implement a structural gradient already in the substructure.

3.2.1. Concrete

The surfaces of concrete ceilings or any sloping screed that may be necessary must be rubbed off, free of gravel pockets and gaping cracks, sufficiently hardened and dry on the surface.

Joints between precast concrete parts must be closed or covered in a dimensionally stable manner.

3.2.2. Wood materials

Substructures made of wood materials are among the light substructures.

Wood formwork must have a CE label in accordance with EN 14081-1. The individual boards of the wooden formwork should be 8 - 16 cm wide and have a thickness of at least 24 mm. The wood should be impregnated, whereby wood protection measures must not have a harmful effect on the roof structure.

Suitable wood-based materials are e.g.: OSB boards according to EN 300, plywood according to EN 636, rigid fibreboards in accordance with

EN 622-2; resin-bonded chipboard in accordance with EN 312, cement-bonded chipboard in accordance with EN 634-1 and solid wood panels in accordance with EN 13353. The panels must be at least 22 mm thick.

3.2.3. Steel trapezoidal profiles

The steel trapezoidal profiles, which are also included among light constructions, must not exceed a maximum deflection of 1/300 in the middle of the surface and 1/500 of the span (between purlins or girders) for surfaces without gradients. The sheet thickness should be at least 0.88 mm. The upper chords should be on one level, with glued roof structures the heights of adjacent upper chords should not differ by more than 2 mm.

3.3. Vapor barriers

For roofs with insulation below the waterproofing, a vapor barrier must normally be installed between the substructure and the insulation layer. This is an essential component of the building's moisture and heat protection.

Suitable materials are bitumen membranes, polymer membranes and composite films, e.g. the KÖSTER Vapor Barrier FR.

Vapor seals can be installed loosely or glued point by point, in strips or over the entire surface.

Vapor barriers must be raised up and connected to the top edge of the insulation at junctions and transitions. They must also be connected to penetrations.

When installing on trapezoidal sheets, the vapor barrier (e.g. KÖSTER Vapor Barrier FR) must be installed in the direction of the upper chords. The longitudinal seam must lie on an upper chord. An auxiliary support (e.g. a metal strip) must be installed under the cross seams.

If the vapor barrier is to act as an emergency seal at the same time, only suitable products must be used (e.g. adhered bitumen membranes).

3.4. Insulation

Suitable materials for thermal insulation include: mineral wool insulation in accordance with EN 13162; rigid polystyrene foam EPS in accordance with EN 13163; extruded polystyrene foam XPS in accordance with EN 13164; rigid polyurethane foam in accordance with EN 13165 and foam glass in accordance with EN 13167.

Insulation materials that serve as a base for a waterproofing seal must comply with minimum pressure load values.

Minimum values, pressure load

Insulating material	Pressure load in kPa	
	Roofs not in use	Roofs in use
EPS rigid foam	100	150
XPS rigid foam	200	300
PU rigid foam	100	100
Foam glass	500	500
Mineral wool	60 at 10 % compression	70 at 10 % compression

When using mineral wool, a load-distributing layer should be placed above or below the waterproofing for roofs that are in use or in the area of maintenance routes to avoid point loads.

Thermal insulation materials should be laid butt-jointed in the joint offset. Ideally, insulating panels with shiplap should be used to avoid thermal bridges.

For panels thicker than 160 mm, the thermal insulation should consist of two layers. Insulation panels can be installed as loose, glued or mechanically fastened.

The insulation panels must be protected against wind suction forces in accordance with EN 1991-1-4.

The mechanical fastening of the insulation can be implemented together with the mechanical fastening of the waterproofing.

Gradient insulation can be used to create gradient wedges or flat gradients.

Gradient insulation is produced by the manufacturer especially for a building project and is supplied along with an installation plan.

In the case of inverted roofs, the insulating materials are installed above the waterproofing. Suitable materials such as XPS insulation with shiplap must be used in this respect. A filter fleece must be installed above the insulation layer as trickling protection and as ballast. The layers above the insulation must be permeable.

3.5. Separating layers / protective layers

KÖSTER roofing membranes are free of volatile plasticisers, bitumen compatible and can be installed on all common thermal insulation materials or bituminous substrates without a separating layer.

Fire protection layers may be prescribed; a commercially available raw glass mat A2 120 g/m² is suitable for this. For further information please contact KÖSTER BAUCHEMIE AG.

For direct installation on concrete or wooden formwork and on old bitumen roofs, KÖSTER roofing membranes with fleece lamination backing or a polyester fleece ≤ 300 g/m² must be used as a protective layer and separating layer against mechanical damage.

For roofs with ballast, KÖSTER recommends a protective layer made of rot-proof fleece, protective mats for buildings or other suitable materials.

When gravel is conveyed pneumatically, a protective layer is urgently required to avoid mechanical damage caused by gravel.

3.6. Waterproofing

KÖSTER TPO and ECB membranes are used for roofing and waterproofing.

The TPO and ECB membranes can be implemented in various designs. These depend on how the buildings are used and on their roof surfaces, the substructure, planning requirements and the generally applicable state of the art.

3.6.1. Application / Installation method

The application of KÖSTER roofing and waterproofing membranes depends on the field of application and the type of installation.

Application / Installation type	KÖSTER TPO	KÖSTER TPO F	KÖSTER TPO F (FR)	KÖSTER TPO SK (FR)	KÖSTER TPO U
	KÖSTER ECB	KÖSTER ECB F			KÖSTER ECB U
Loosely installed under ballast / green roof	✓	✓	✓		
Exposed to the weather Mechanically fastened	✓	✓	✓	✓	
Exposed to weather Strip and full-surface adhesion		✓	✓		
Exposed to weather, fully self-adhesive				✓	
Exposed to the weather – direct installation on EPS Glued or mechanically fastened			✓	✓	
Connection strips at the attic, wall connections, skylight dome etc., loose or glued with KÖSTER contact adhesive or self-adhesive	✓			✓	
Production of fan and storm drain flanges, pipe penetrations and corner protections					✓

Installation types

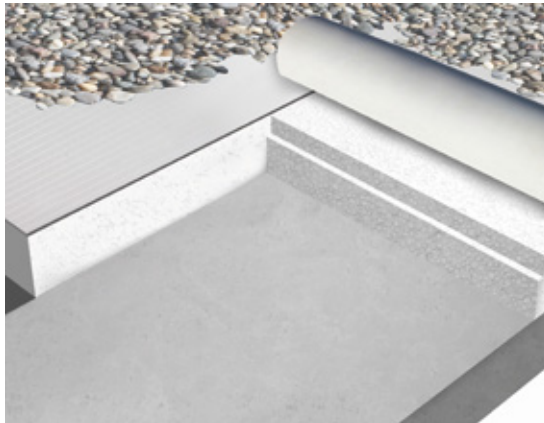

Loosely installed with ballast

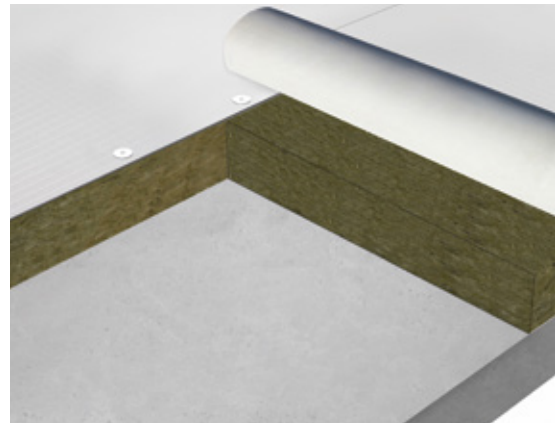

Mechanically fastened installation

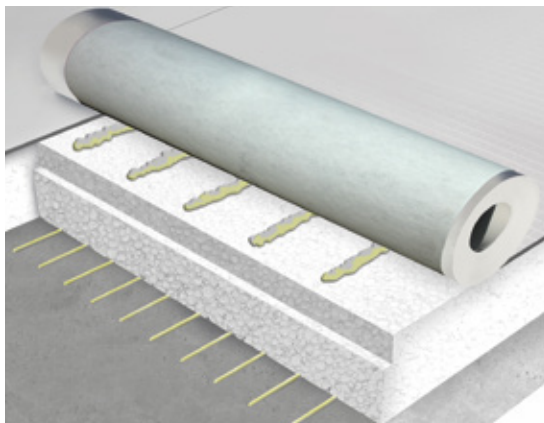

Adhered installation with adhesives

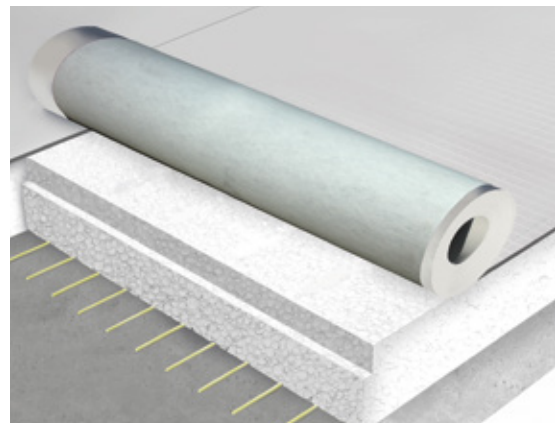

Self-adhesive installation

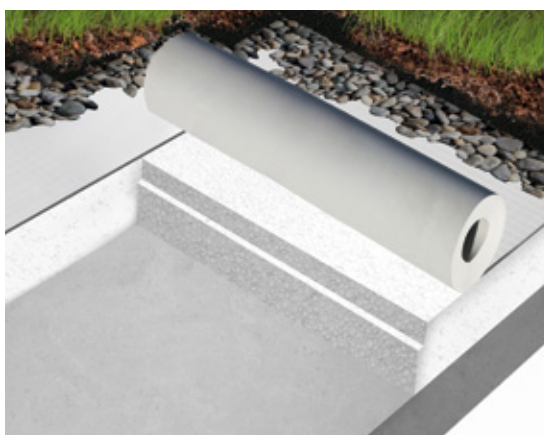

Green roofs

3.6.2. Overlap

The lateral overlap of KÖSTER roofing and waterproofing membranes is generally at least 5 cm.

Depending on the fastening method and type of insulation material, the seam overlap may increase.

Seam overlap according to the application:

Substrate	Loosely installed with ballast	Strip-by-strip gluing / Self-adhesive	Full-surface gluing	Mechanically fastened
Concrete	50 mm	50 mm	80 mm	110 mm
Wood / wood materials	50 mm			110 mm
Insulation materials – except EPS	50 mm	50 mm	80 mm	110 mm
EPS insulation	80 mm	80 mm	80 mm	110 mm

Seam overlaps against the water flow are permitted for junctions and transitions and on built in parts.



3.6.3. End butt joints / cross butt joints

In the case of non-laminated KÖSTER TPO roofing membranes, the end butt joints are produced with at least a 5 cm overlap. For EPS insulation or mechanical fastening, the overlap must be increased accordingly.

Fleece-laminated KÖSTER TPO roofing membranes are installed with butt joints and covered with a non-laminated TPO strip cut to 25 cm wide, which is welded to both sides of the membrane.

Self-adhesive KÖSTER TPO roofing membranes are overlapped at the end butt joint approx. 5 cm and pre-welded. Then proceed as with the fleece-laminated waterproofing membranes.

The overlap strip must project at least 5 cm over the edge of the membrane.

All corners (e.g. at the end of the membrane) are rounded to ensure faultless welding of the membranes. This step applies to both the lower and upper layers.

Cross butt joints are a weak point and should be avoided at all costs. Better are offset overlaps or welding a cover strip that avoids a cross butt joint.

3.6.4. Weld seam width

The width of the homogeneous joint must be at least 20 mm for KÖSTER TPO and KÖSTER ECB roofing membranes.

3.7. Safety measures

3.7.1. Securing against horizontal forces

Horizontal forces occurring in the waterproofing layer must be absorbed to avoid adverse effects on the roof structure. To this end, single-layer waterproofing made of KÖSTER roofing membranes, regardless of the installation method, the substructure and the building height, is mechanically fastened to all junctions and transitions, roof edges as well as to all built-in parts.

Composite sheet angles, roofing membrane fasteners or rigid rails are suitable for fastening. These must be fastened with at least 3 fastening elements per meter. The fastenings must be arranged and implemented in or directly above the waterproofing level in the transition to vertical or inclined surfaces. For large insulation thicknesses, it is recommended that the fastening be implemented in the rising construction or auxiliary construction.

If the roof surface gradient changes direction > 7 % (approx. 4°) the waterproofing membrane must be mechanically fastened at the low point in accordance with the edge fastening.

3.7.2. Protection against wind suction forces

Roofing membranes must be secured against lifting by wind suction forces. KÖSTER TPO and ECB roofing membranes are mechanically fastened, glued or secured via ballast.

A combination of mechanical and glued fastening is not permitted.

The number of fasteners, the quantities of adhesive or the necessary ballast must be determined by a wind load calculation in accordance with EN 1991-1-4 or by the simplified specifications in the flat roof guidelines.

Wind loads acting on the building depend on the building's location, height, roof form and roof pitch.

As a free service, KÖSTER BAUCHEMIE AG prepares fastening plans for its customers in accordance with EN 1991-1-4, wind loads on buildings.

3.7.2.1. Mechanical fastening

Mechanical fastening is undertaken in the overlapping area of the roofing membranes. In accordance with the wind load calculations, fasteners may also be required in the centre of the roofing membrane in certain areas. These must be covered with a 250 mm wide KÖSTER TPO welded strip.

The membranes must be anchored in the substructure with approved roofing membrane fasteners in accordance with the fastening plan. The length and type of fasteners depend on the substructure and the thickness of the roof insulation being used. Fasteners of different lengths must be used for gradient insulation. In one work step, the entire roof layer package is to be fastened in a windproof manner. For certain insulating materials, additional fastening may be necessary in accordance with the manufacturer's installation guidelines. For trapezoidal sheet steel constructions, the roof layer package is fastened in the upper chords of the trapezoidal sheeting. The KÖSTER roof membranes are laid transversely to the direction of the trapezoidal sheeting.

With wooden formwork, the waterproofing membranes are also laid transversely to the course of the formwork.

The fasteners are installed parallel to the membrane edge at intervals of 10 mm.

Penetration-resistant fastening elements must be used for mineral fibre insulation.

If existing thermally insulated roof structures are used for renovation work, corrosion-resistant fasteners must be used.

3.7.2.2. Adhesion

Only KÖSTER TPO F roofing membranes with fleece lamination or KÖSTER TPO SK (FR) roofing membranes should be used. The fleece must be dry during work.

The roofing membranes should be stored in a dry place.

When applying the adhesive, make sure that the weld area remains free of adhesives. If necessary, adhesive residues must be removed mechanically. See section 8.2. Welding.

Adhered installation can only be undertaken for renovation if the old roof structure is still securely adhered in place or if it has been mechanically fastened subsequently in accordance with EN 1991-1-4.

Subsequent adhesion of the old roof structures is not permitted.

3.7.2.2.1. Full-surface adhesion

The entire surface is adhered with KÖSTER PUR Membrane Adhesive or other suitable PUR roofing membrane adhesives.

The consumption of the KÖSTER PUR Membrane Adhesive for full-surface adhesive is approx. 400 to 450 g/m². Apply the adhesive evenly over the entire surface of the prepared substrate using suitable tools, e.g. rubber lip squeegee.

Due to their bitumen compatibility, KÖSTER TPO F roofing membranes can also be installed in hot bitumen or in suitable bitumen membranes.

Adhering with bitumen must always be undertaken over the entire surface. Light-colored KÖSTER TPO roofing membranes may discolor when glued with bitumen adhesives. However, this has no influence on the quality and durability of the roofing membranes.

3.7.2.2.2. Stripe adhesion

Only PUR roofing membrane adhesives are to be used for adhesion in stripes. The adhesive is applied in stripes in parallel lines.

The roof area is divided as per a wind suction calculation in accordance with EN 1991-1-4 or the specifications in the flat roof guidelines.

Consumption according to roof area division:

Roof area	Number of strips per m	Adhesive consumption
Interior	4	ca. 160 g / m ²
Inner edge area	5	ca. 200 g / m ²
Outer edge area	6	ca. 240 g / m ²
Corner area	8	ca. 320 g / m ²

The strip width should be approx. 2 cm.
(Consumption 25 - 40 g / m)

Stripe Adhesion System



3.7.2.2.3. Self-adhesive installation

KÖSTER TPO SK (FR) roofing membranes have a lamination made of special polyester fleece with a self-adhesive layer.

The substrate must be solid, clean, dry, free of grease and oil.

Depending on the substrate, application of KÖSTER TPO SK primer may be necessary.

The primer is applied over the entire surface in a single operation using a roller or brush. It is absolutely necessary to check for thorough drying before installing KÖSTER TPO SK (FR) roofing and waterproofing membranes.

The consumption is approx. 200 ml/m².

The manufacturer's instructions must be observed for aluminium-laminated PUR / PIR

insulation. Non-laminated PUR / PIR insulating materials, tongue and groove cladding, and pressed gravel roofs are not suitable.

For other substrates please contact KÖSTER BAUCHEMIE AG.

KÖSTER TPO SK (FR) membranes are rolled out and aligned. The protective film is then pulled out laterally under the laid membrane. Make sure that the membrane does not slip.

Note: At high working temperatures it may be necessary to roll the membranes back up to halfway after laying them and to separate the film transversely. The film must be removed when rolling it out again.

Finally, the membrane must be thoroughly pressed down over its entire surface using a roller. The seams are sealed via hot air welding.

Substrate	Direct Installation	KÖSTER TPO SK Primer
EPS insulation, non-laminated	✓	
XPS insulation, non-laminated	✓	
PUR/PIR insulation, fleece-laminated*	✓	
PUR/PIR insulation, aluminium-laminated*	✓	
Mineral fibre insulation, fleece-laminated*		✓
Bituminous membrane as initial covering (KSA)	✓	
Slate or sanded bitumen membrane		✓
Old bitumen roof (stable)		✓
Concrete		✓

*Must be approved by the adhesive manufacturer

Hot air welding of the seams



3.7.3. Securing with ballast

3.7.3.1. Ballasts

If a ballast is provided, the membrane can be laid loosely on the roof surface without further fastening.

The required surface weight of the ballast can be determined by a wind suction calculation in accordance with DIN EN 1991-1-4. The material used must be applied in such a way that it is stable and wind-resistant. In edge and corner areas, it is recommended to use slabs or grass pavers.

Suitable ballasts are:

- Round gravel 16/32, at least 5 cm
- Slabs, shaped stones, frost-resistant concrete slabs
- Greening, KÖSTER TPO is tested in accordance with the FLL method
- Layers of earth
- Using a protective layer is recommended when utilising ballasts (see section 3.5. Separating layers / protective layers

3.7.3.2. Green roofs

As a form of building greening, green roofs are a part of ecological building.

A distinction is made between extensive and intensive green roofs.

The standard structure of a green roof is independent of the type of greening. In any case, the green roof guidelines must be observed.

Standard layer construction for green roofs:

- Plant level
- Vegetation layer
- Filter layer
- Drainage layer
- Protection layer
- Roof construction with KÖSTER TPO

KÖSTER TPO and ECB roofing membranes are root-resistant and do not require additional root penetration protection.

Due to the expected loads, it is absolutely necessary to check the load-bearing capacity of the roof structure.

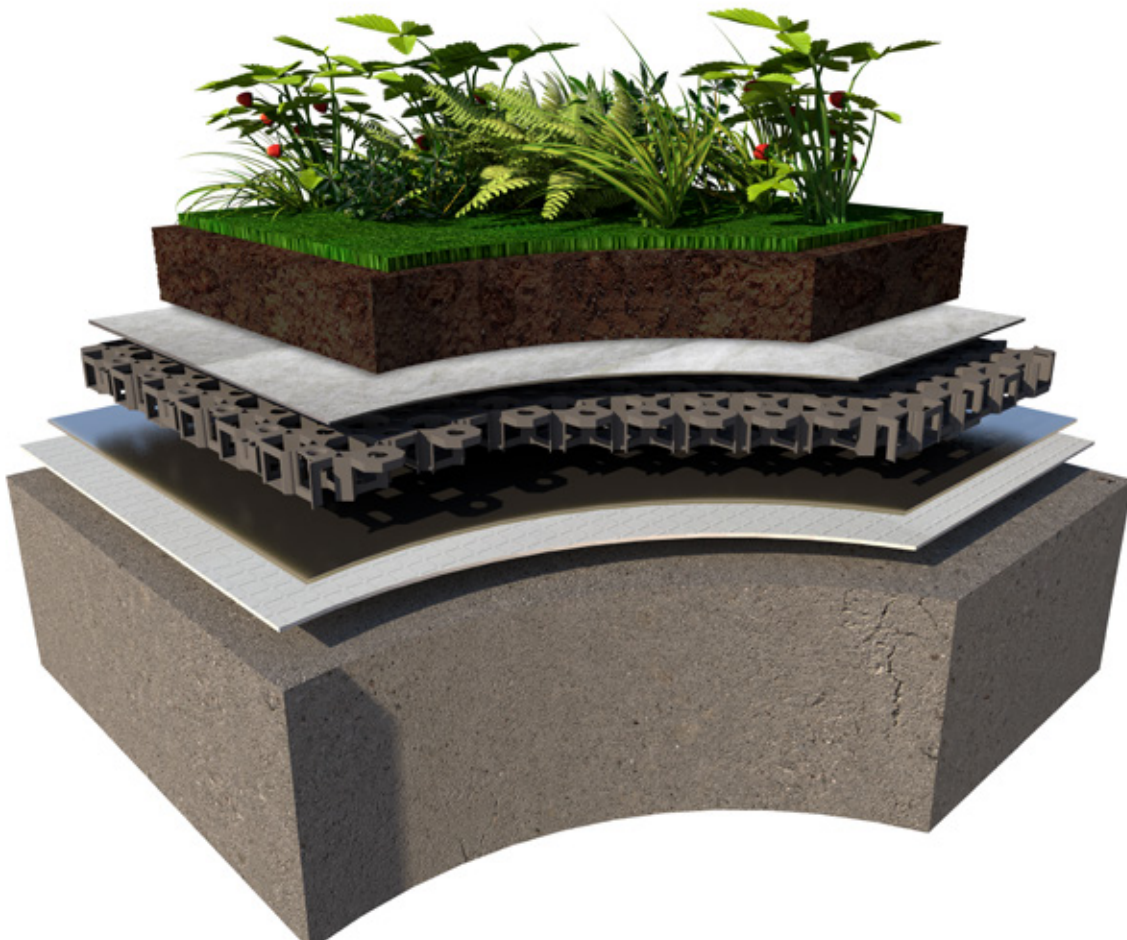

3.7.3.2.1. Extensive green roof

Extensive green roofs can usually be produced and maintained with little effort. Additional watering is not necessary. They are placed close to nature and are intended to be self-maintaining and developing. Various types of sedum are used alongside grasses, mosses and herbs.

Installation height

Extensive greening has an installation height of approx. 6 to 15 cm and a surface weight of between approx. 0.5 and 1.5 kN/m².

3.7.3.2.2. Intensive green roof

Roofs with intensive roof greening are usually multifunctional and accessible. They resemble construction of a roof garden. Intensive greening has a significantly higher weight and a thicker system structure. Depending on the layer thickness, almost all plants are an option, such as grass, perennials, shrubs, trees, along landscaping elements, such as ponds, pergolas and terraces. Maintenance must be carried out regularly and depends on the design and the selected plants.

Installation height

An intensive greening has an installation height of approx. 15 to 200 cm and a surface weight of between approx. 2 and 30 kN/m².

Extensive green roof



Intensive green roof



3.8. Detailing

3.8.1. General planning principles

Already at the planning stage, the prerequisites must be prepared for professional implementation of detailing for flat roof waterproofing. The heights of waterproofing at junctions and transitions, distances between penetrations and drainage points and from rising components or roof edges, and the implementation of detailing should be planned and determined in advance of a construction project.

3.8.2. Junctions and transitions

3.8.2.1. Junctions to rising components

Junctions and transitions to rising components, eaves connections, detailing junctions and the like are always implemented in two parts. To produce junctions and transitions, use strips of KÖSTER TPO or KÖSTER TPO SK (FR) cut to size. No junctions can be produced using fleece-laminated KÖSTER TPO F roofing membranes. The material thickness of the junction strips should correspond to the thickness of the membrane. The strips can be installed loosely with junction heights up to 50 cm. Junction strips must always be mechanically secured in the upper area against slipping off and protected against reverse movement, e.g. by using clamping profiles or clamping rails.

At least 4 fasteners per running metre should be used.

Junctions and transitions can also be implemented with canted composite angles.

If surfaces are used, the waterproofing must be protected against mechanical damage, e.g. with protective or cover plates, stone slabs or similar.

Junction heights

Junctions to rising components and built-in parts must be implemented for

- a roof pitch of $\leq 5^\circ$ at least 15 cm
- a roof pitch $> 5^\circ$ at least 10 cm

above the upper edge of the roof covering.

Junctions with a height > 50 cm must either be equipped with mechanical intermediate fastening or be fastened via gluing or self-adhesion over their entire surface.

Alternatively, a tensioned junction can be undertaken up to a junction height of 1.2 m.

Mechanical securing can be achieved using individual fasteners, rigid rails or composite metal strips. At least 3 fastening elements per metre must be used.

Mechanical fastenings are implemented in the overlap or must be covered with KÖSTER TPO pre-cut parts.

KÖSTER contact adhesive is used for full-surface gluing of the KÖSTER TPO roofing membranes.

The consumption is approx. 400 g/m² (per side 200 g / m²).

Contact adhesive



3.8.2.1.1. Example wall junction up to 50 cm junction height

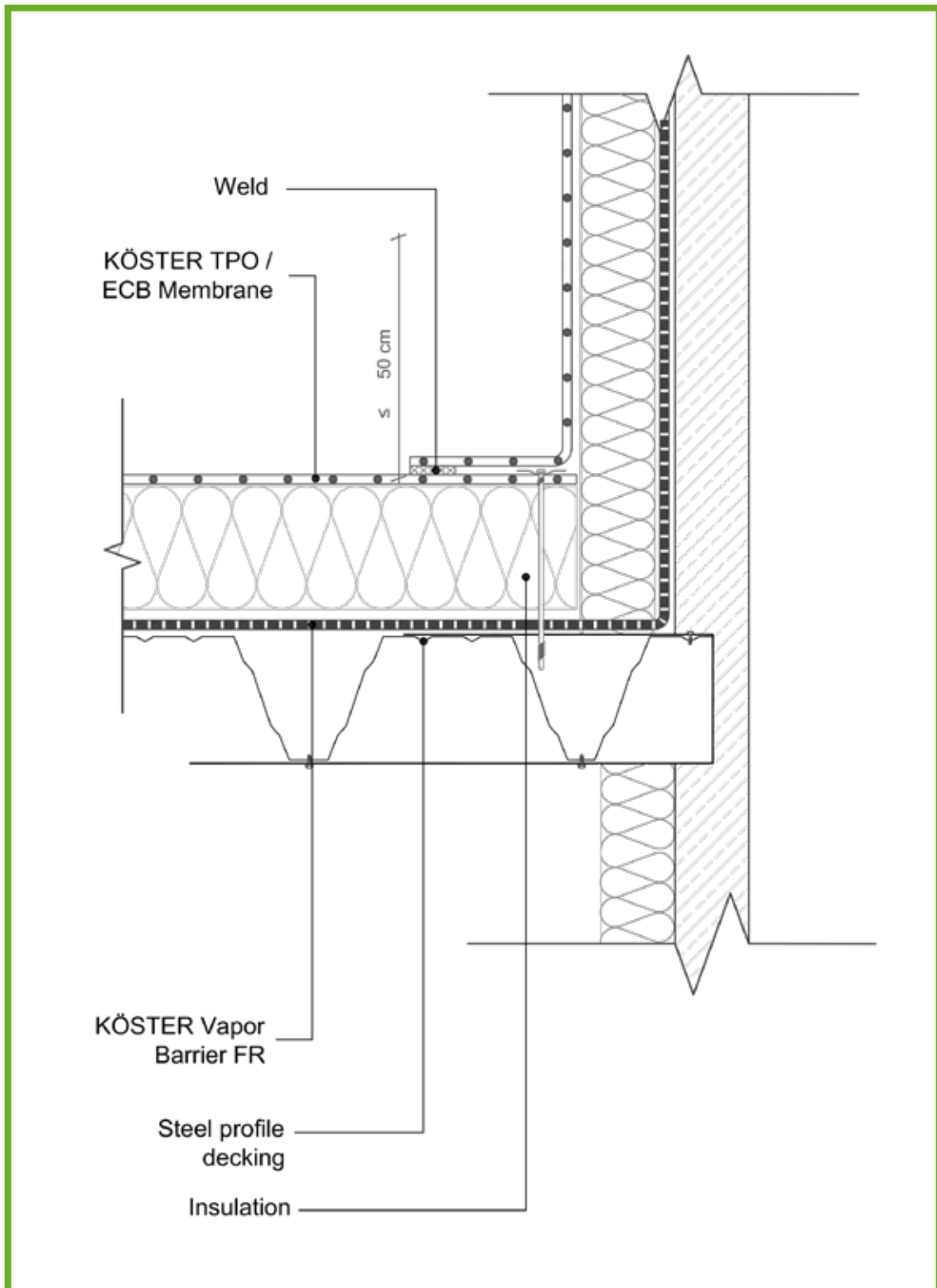

Wall junction up to 50 cm junction height

3.8.2.1.2. Example wall junction over 50 cm junction height

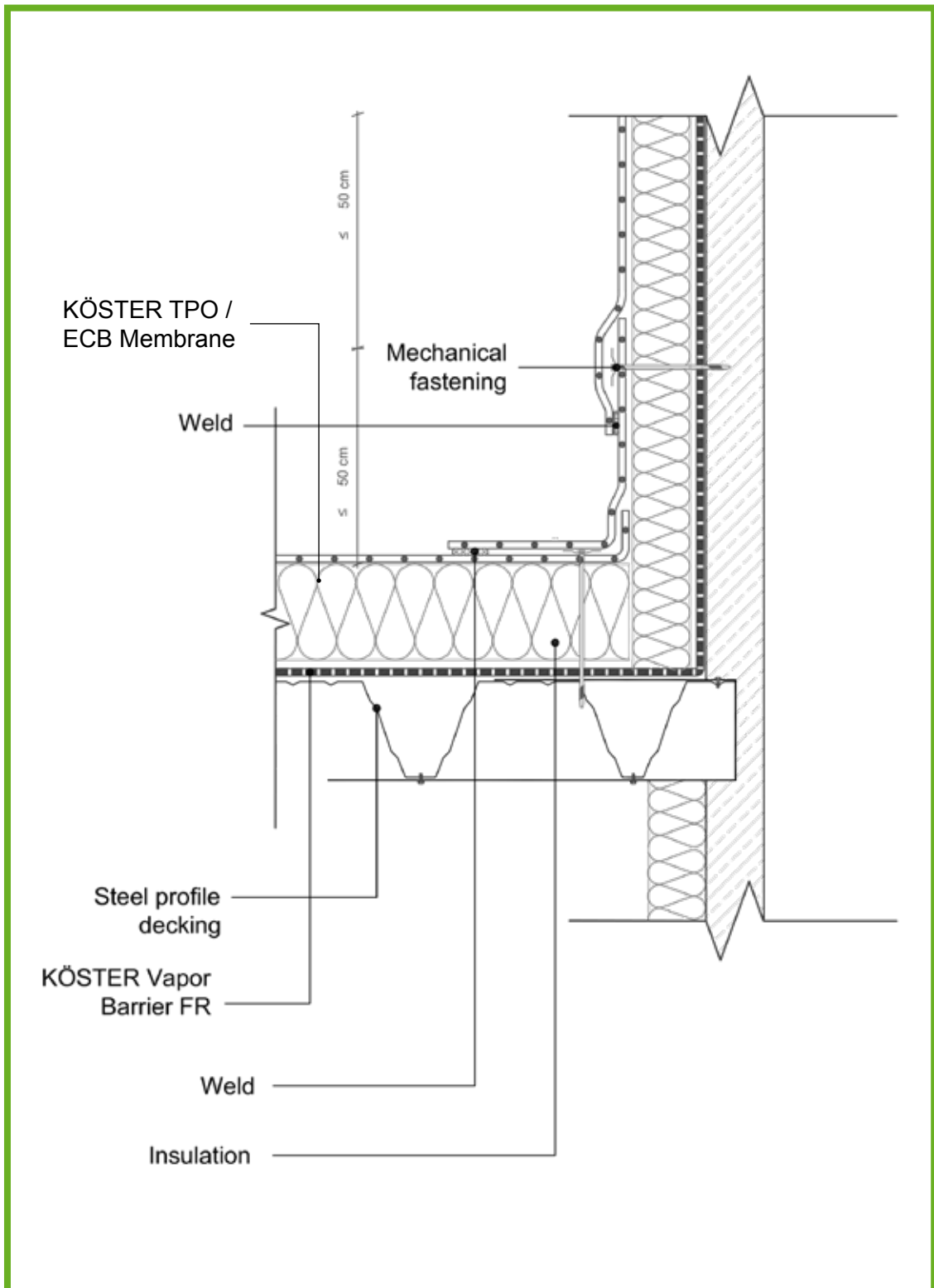

Wall junction over 50 cm junction height

3.8.2.1.3. Junction to row of windows and skylight dome

Junctions to skylight domes or rows of windows are implemented as per junctions to rising components. Junction strips can be laid loosely up to a height of 50 cm. Gluing with KÖSTER contact adhesive or using the TPO SK (FR) membrane is also possible. The junction strips must be mechanically fastened in the upper area to prevent slipping off. The junction must be secured against water backflow.

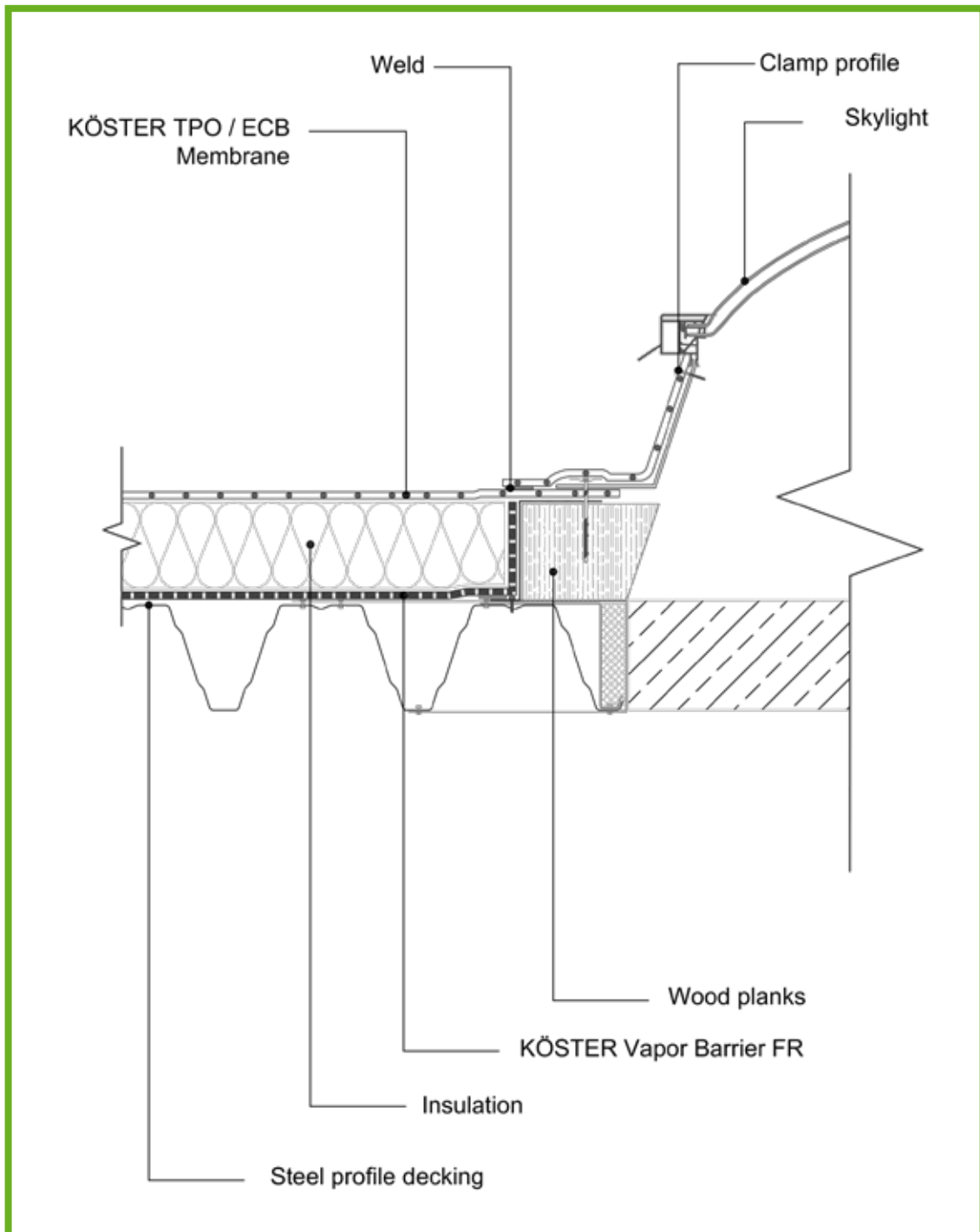

Junction to skylight dome

3.8.2.2. Junction to doors

Junctions to door thresholds can be implemented in the same way as for wall junctions. The junction height for doors should also be at least 15 cm above the roof covering surface. This is to prevent rainwater from penetrating over the door threshold via slush, driving rain, backwater, wind pressure or ice formation.

If the junction height is low, it must be ensured that perfect water drainage is guaranteed in the area of the door element. This can be achieved using a channel-shaped drainage grate or similar constructions with direct connection to the drainage or with drainage grates on

support pads for floor coverings. The width of the gratings should be at least 15 cm. These constructions should be installed directly in the junction area to the door element. The junction height for this design should be at least 5 cm. It is recommended to protect the junction with roofing in the door area.

Additional measures are required for barrier-free door junctions. These include, for example: protection against driving rain and splashing water using roofing, door frames with flange constructions, doors with special waterproofing constructions and the like.

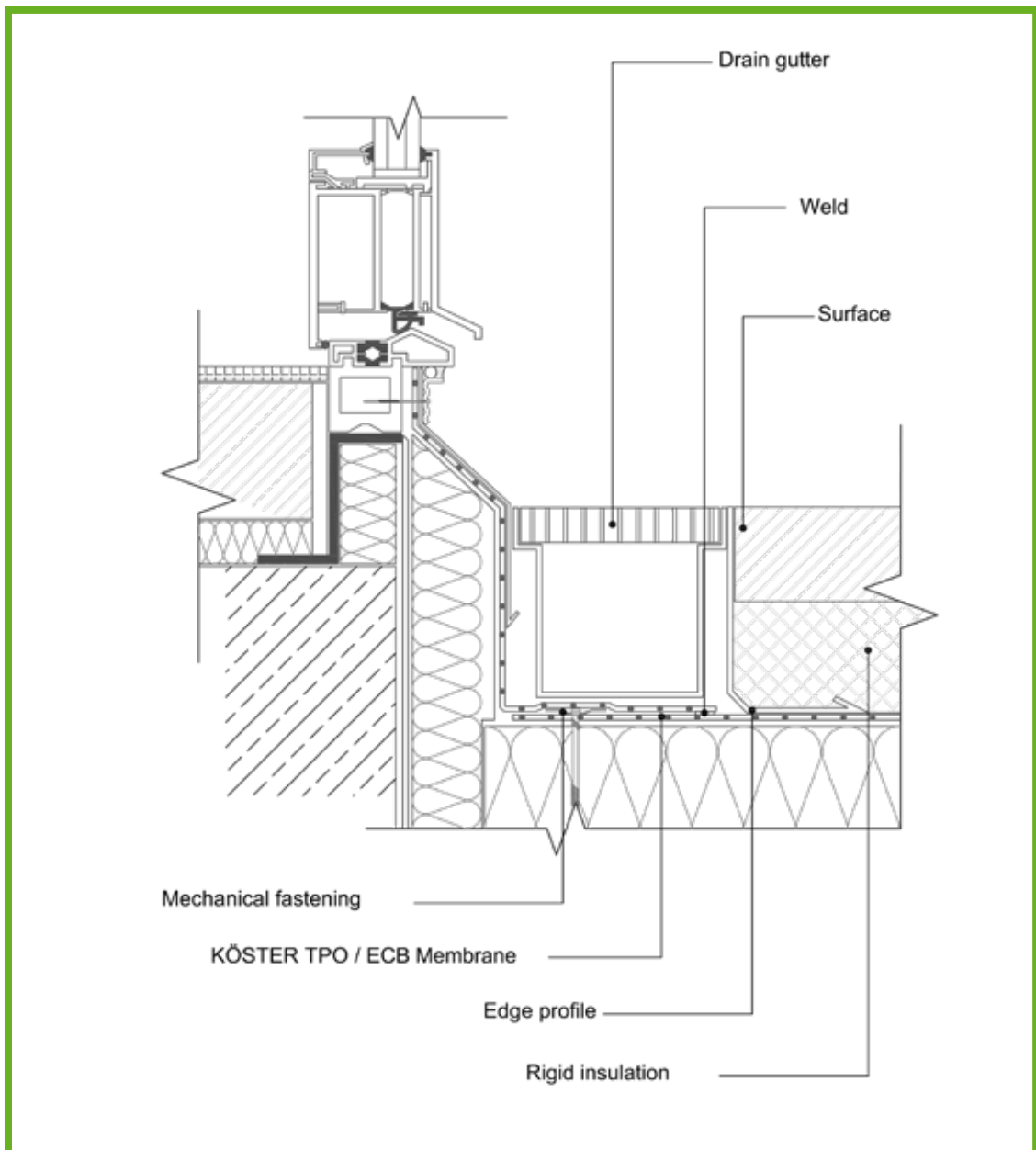

Junction to a door

3.8.2.3. Roof edge transitions

An edge transition is required on the roof edges of flat roofs. Exceptions are only junctions to roof gutters or drip edges.

The edge transition can be implemented with edge canting with roof edge covers, upstands with roof edge transition profiles or with edge transition profiles.

Roof edge transitions should be implemented, for

- a roof pitch $\leq 5^\circ$ at least 10 cm
- a roof pitch $> 5^\circ$ at least 5 cm

above the roof covering.

In the case of upstands, junction membranes made of KÖSTER TPO / ECB roofing membranes should be positioned up to the outer edge and glued or mechanically fastened.

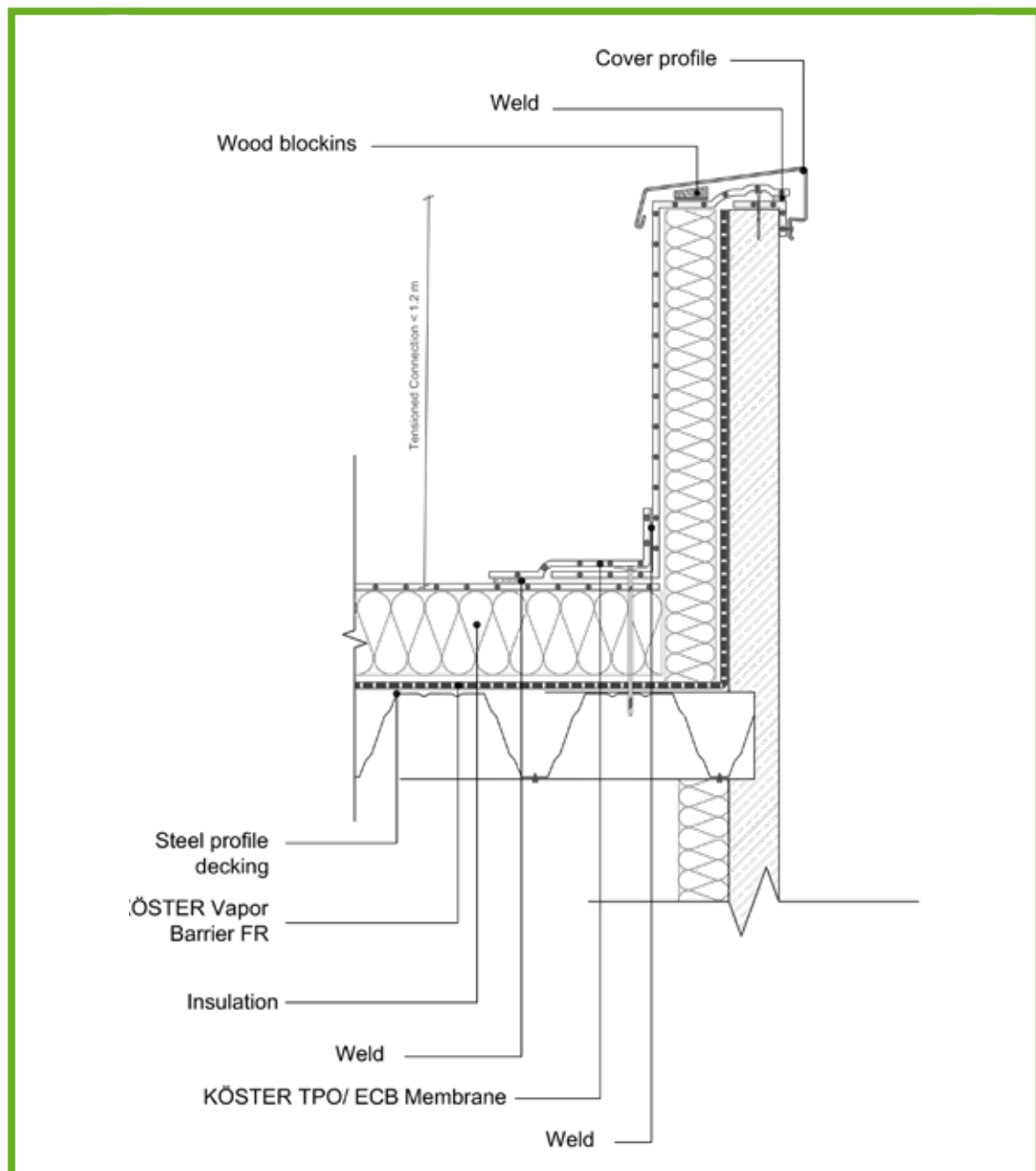

Attica junction

Example roof edge transition

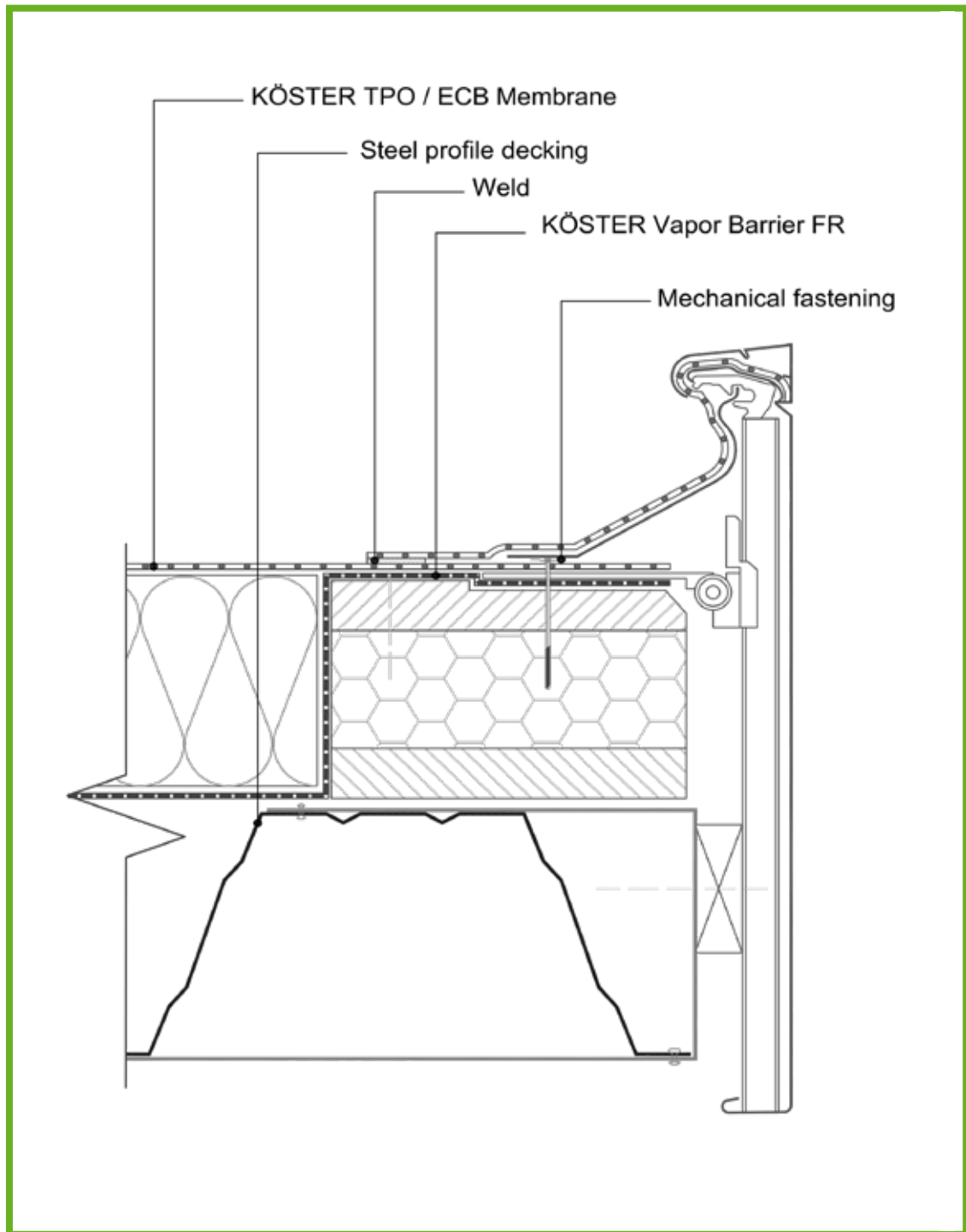

Roof edge transition profile

3.8.2.4. Junctions to eaves

Junctions to roof edges, which serve to drain the roof surface, are produced with folded KÖSTER metal composite sheets. These are cut to size, folded and fastened in accordance with the conditions and recognised engineering practice. The requirements of the ZVDH (National Association of German Roofers) and DIN 18339 plumbing regulations must be observed. KÖSTER roofing membranes can be welded directly onto the composite sheet metal.

With KÖSTER TPO / ECB F or KÖSTER TPO SK (FR) roof membranes, the waterproofing is positioned under the eaves sheeting and fastened to the composite sheet metal. A 250

mm wide cutting strip of KÖSTER TPO is used to make the connection between the sheet metal and the roofing membrane. The strip is welded to the sheet metal and the waterproofing membrane.

The sheets must be mounted at intervals of approx. 5 mm in the joint area. An approximately 120 mm wide strip of KÖSTER TPO U welded around the composite metal sheet covers the joint. It should not be welded directly in the joint area. This can be prevented by applying some masking tape for example.

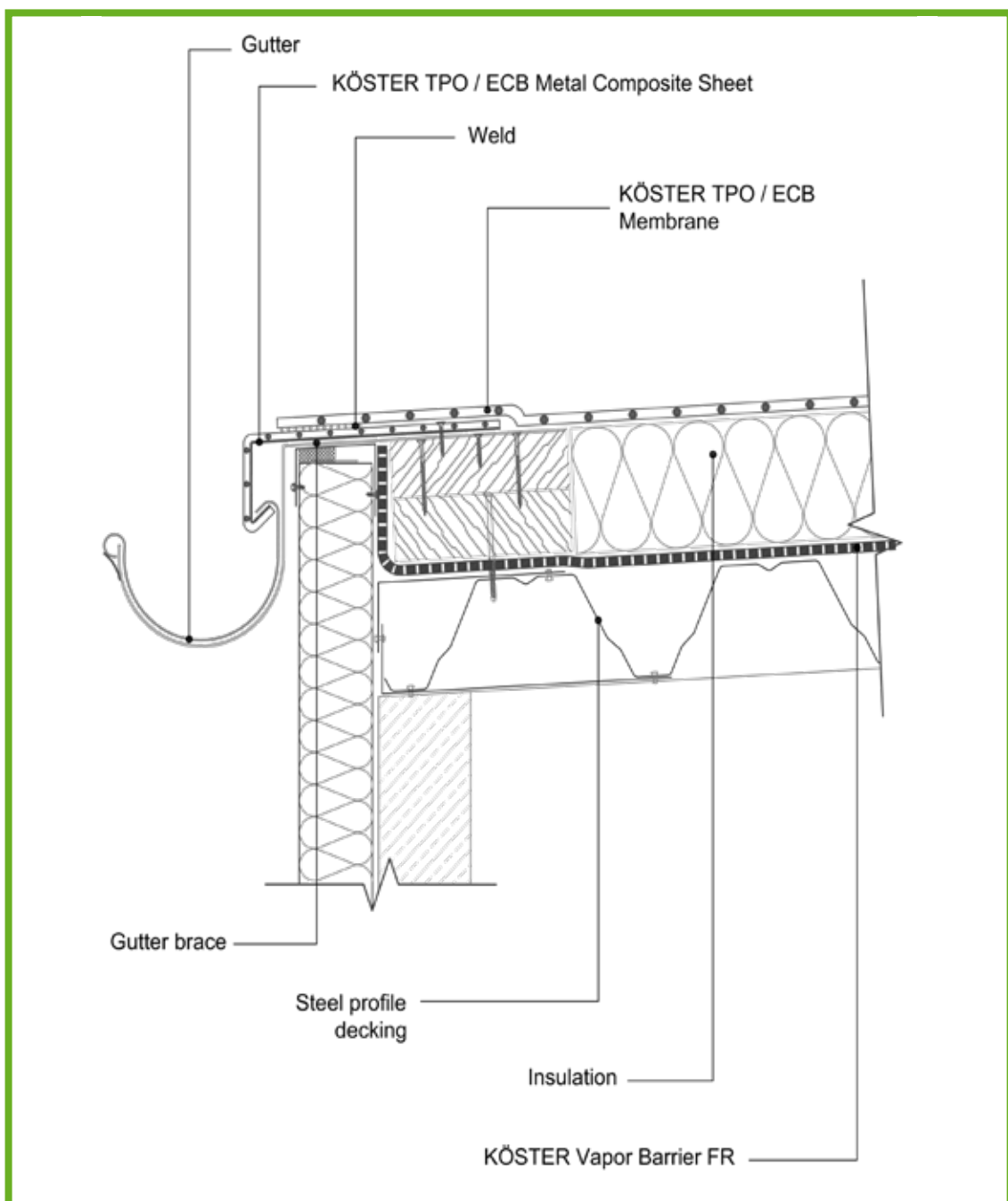

Junction to roof gutter

3.8.2.5. Clamping constructions

3.8.2.5.1. Clamping profiles

Clamping profiles are used to prevent junction strips from slipping off at junctions. Generally, they must be mechanically fastened at intervals of 20 cm. The upper transition must be secured against water ingress using an overhang strip or a sealant grouting.

Sealant grouting requires regular maintenance.

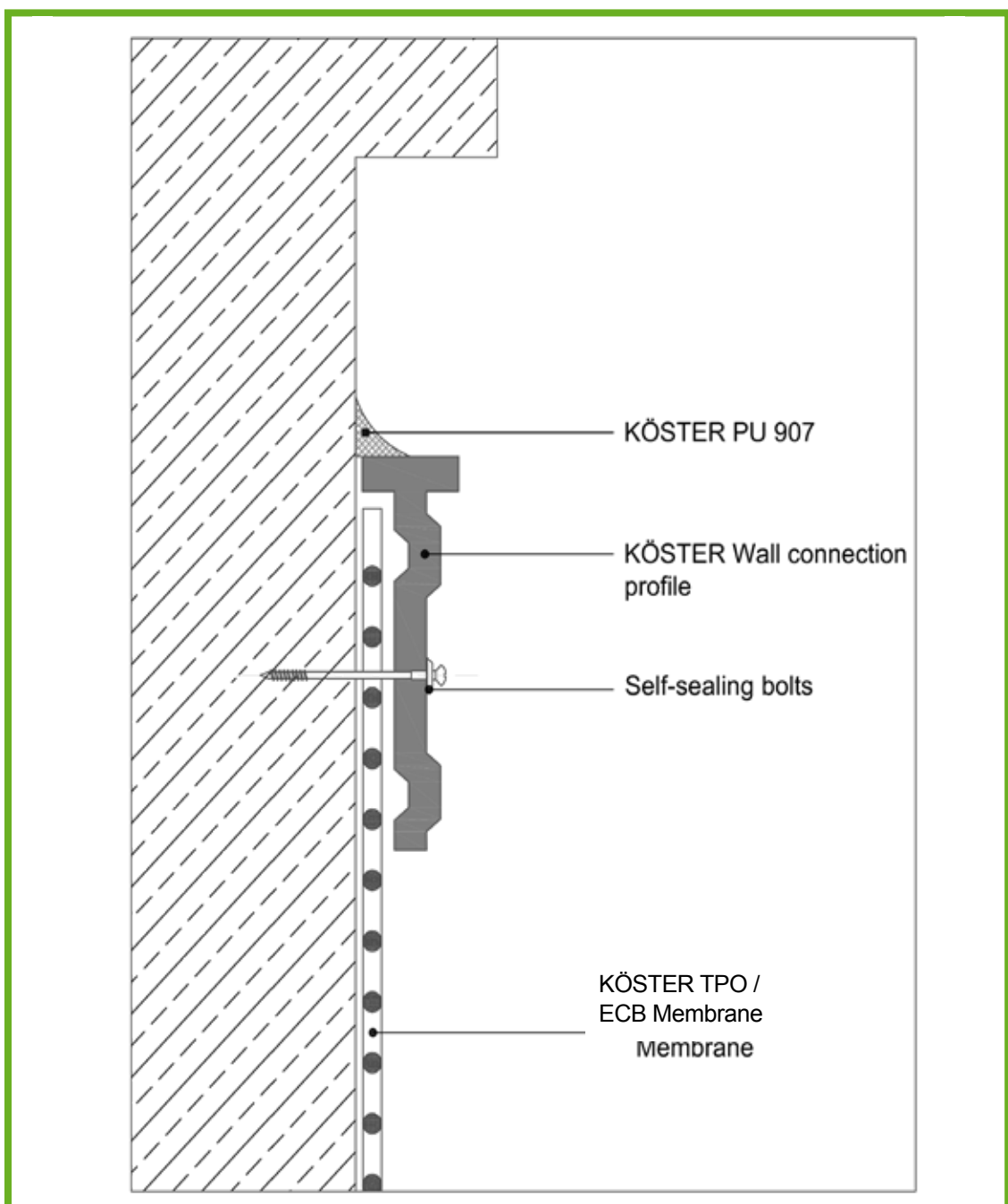

Upper transition with clamping profile

3.8.2.5.2. Clamping rails

With suitable substrates, e.g. concrete, clamping rails can protect junctions against water penetration. Clamping rails must be at least 45 mm wide and 5 to 7 mm thick. They are fastened in dowels with hexagonal screws at 150 mm intervals. The diameter of the screws must be 8 mm. Clamping rails should not be longer than 2.50 m. The waterproofing edge must be clamped between the clamping rail and building surface.

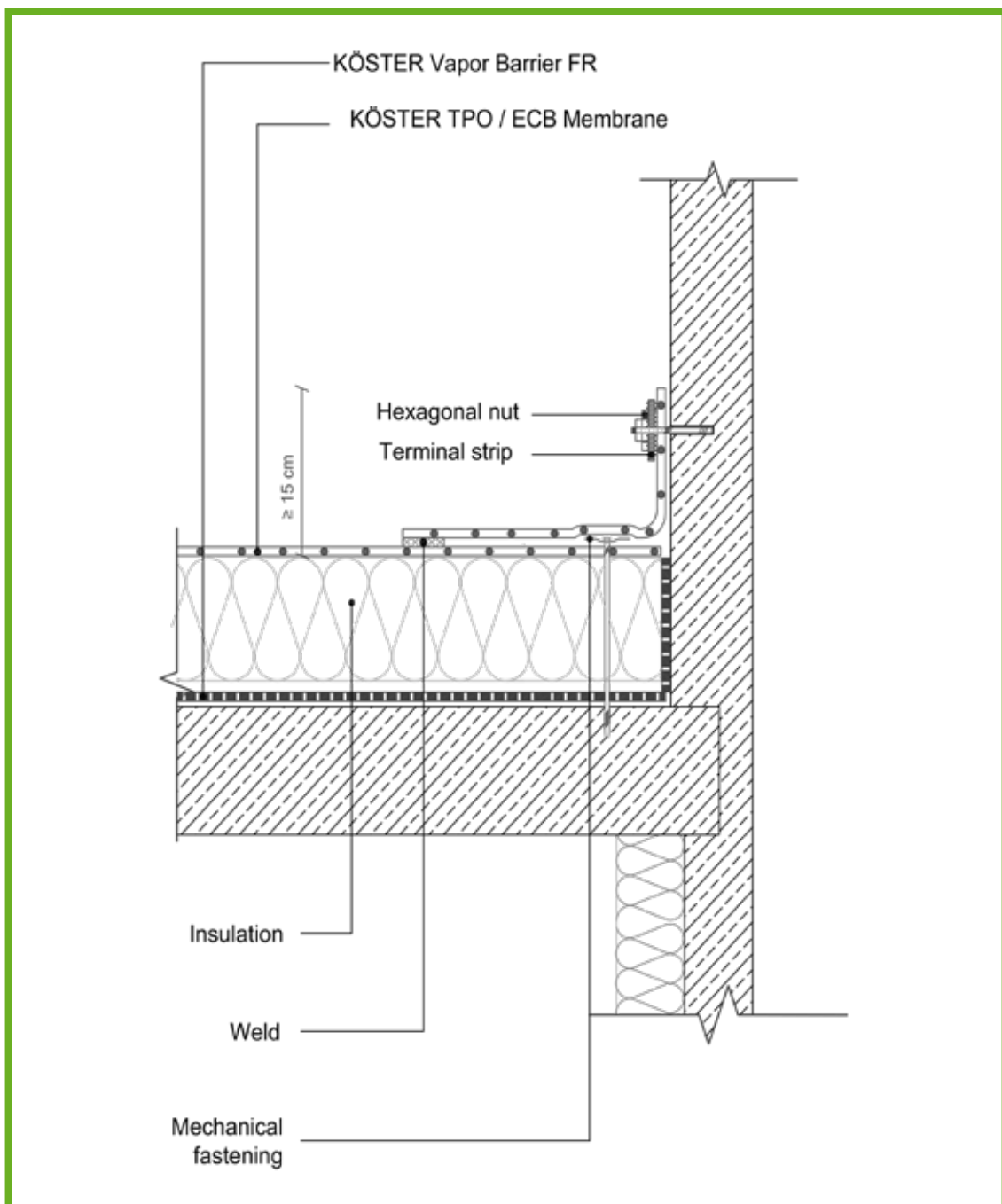

Upper transition with clamping rail

3.8.2.5.3. Loose / fixed flange constructions

Loose/fixed flange constructions are used for watertight connection of KÖSTER roofing membranes to the substructure at penetrations, storm drains, junctions and others. A precondition for a functional loose and fixed flange construction is safe and watertight anchoring of the fixed flange in or on the structural concrete surfaces; under no circumstances in the levelling or inclining concrete. Anchoring can be performed by embedding welded head bolts, brackets or straps in the concrete. The cannulations of the fixed flanges for anchoring must be welded watertight in the pressurised water area and

around all other holes. If full-surface support of the fixed flange is not ensured, e.g. during renovation work, it is recommended to provide a grouting option between the lower edge of the fixed flange and the upper edge of the structural concrete despite the use of levelling mortar.

When installing the waterproofing, the holes required by the threaded bolts must be punched out. No weld seams may be pressed into the flange.

Standard dimensions for loose / fixed flange constructions for loosely installed KÖSTER roofing and waterproofing membranes			
Water accumulation height		< 100 mm	≥ 100 mm
Loose flange	Width	≥ 60 mm	≥ 150 mm
	Thickness	≥ 6 mm	≥ 10 mm
	Edge fitting	ca. 2 mm	ca. 2 mm
Fixed flange	Width	≥ 70 mm	≥ 160 mm
	Thickness (≥ thick loose flange)	≥ 6 mm	≥ 10 mm
Screws / bolts	Diameter	≥ 12 mm	≥ 20 mm
	Interval between each other	75 - 150 mm	75 - 150 mm
	Interval at the end of the loose flange	≤ 75 mm	≤ 75 mm
Welt seam for threaded studs	Width	approx. 2 mm	approx. 2 mm
	Height	approx. 3,2 mm	approx. 5 mm
Punch hole in the loose flange	Diameter	≥ 14 mm	≥ 22 mm
Extension for threaded bolts	Diameter	Diameter + 2 times the weld seam width	Diameter + 2 times the weld seam width

Example of loose / fixed flange constructions

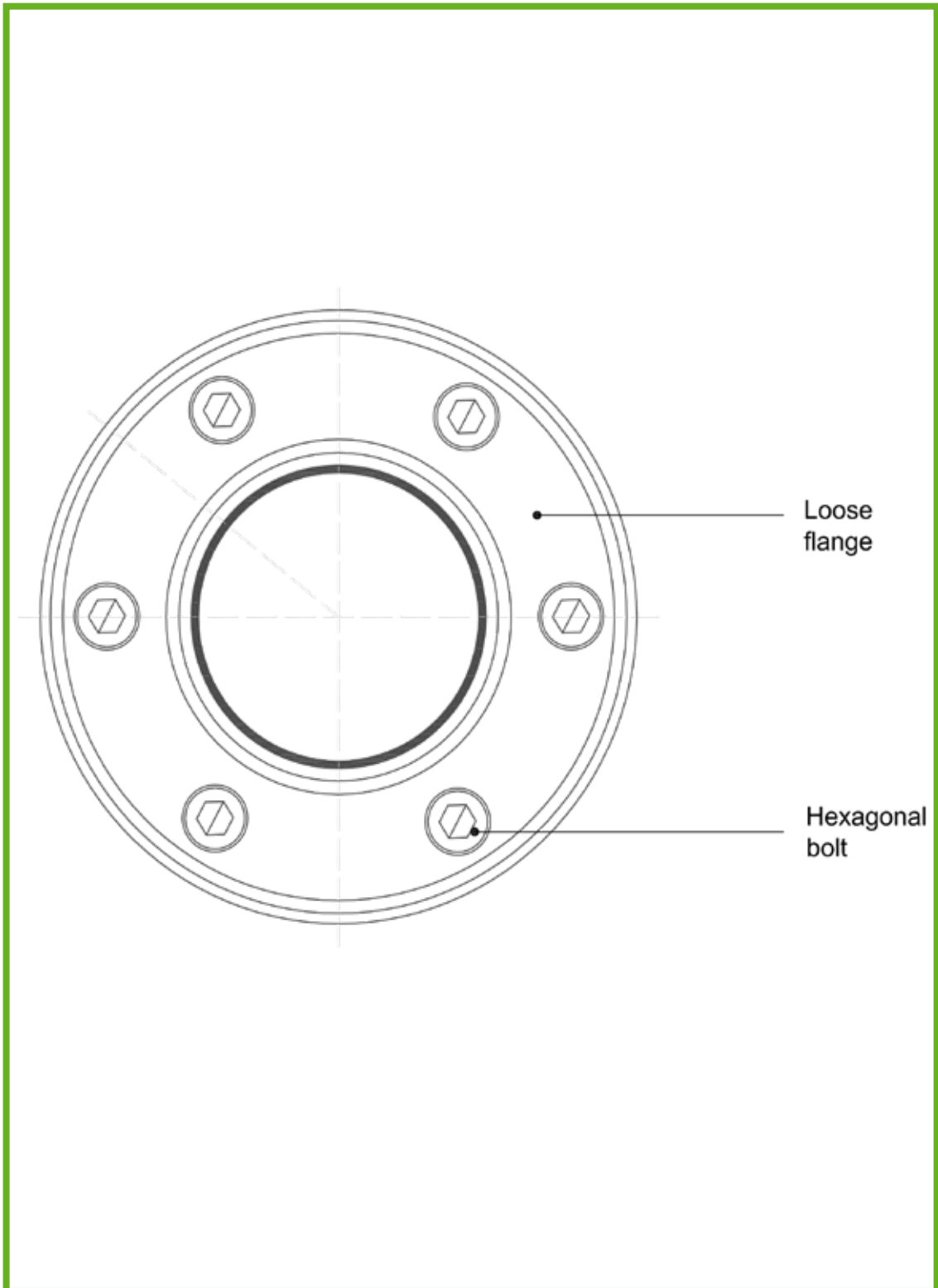

Front view of loose / fixed flange constructions

Example of loose / fixed flange constructions

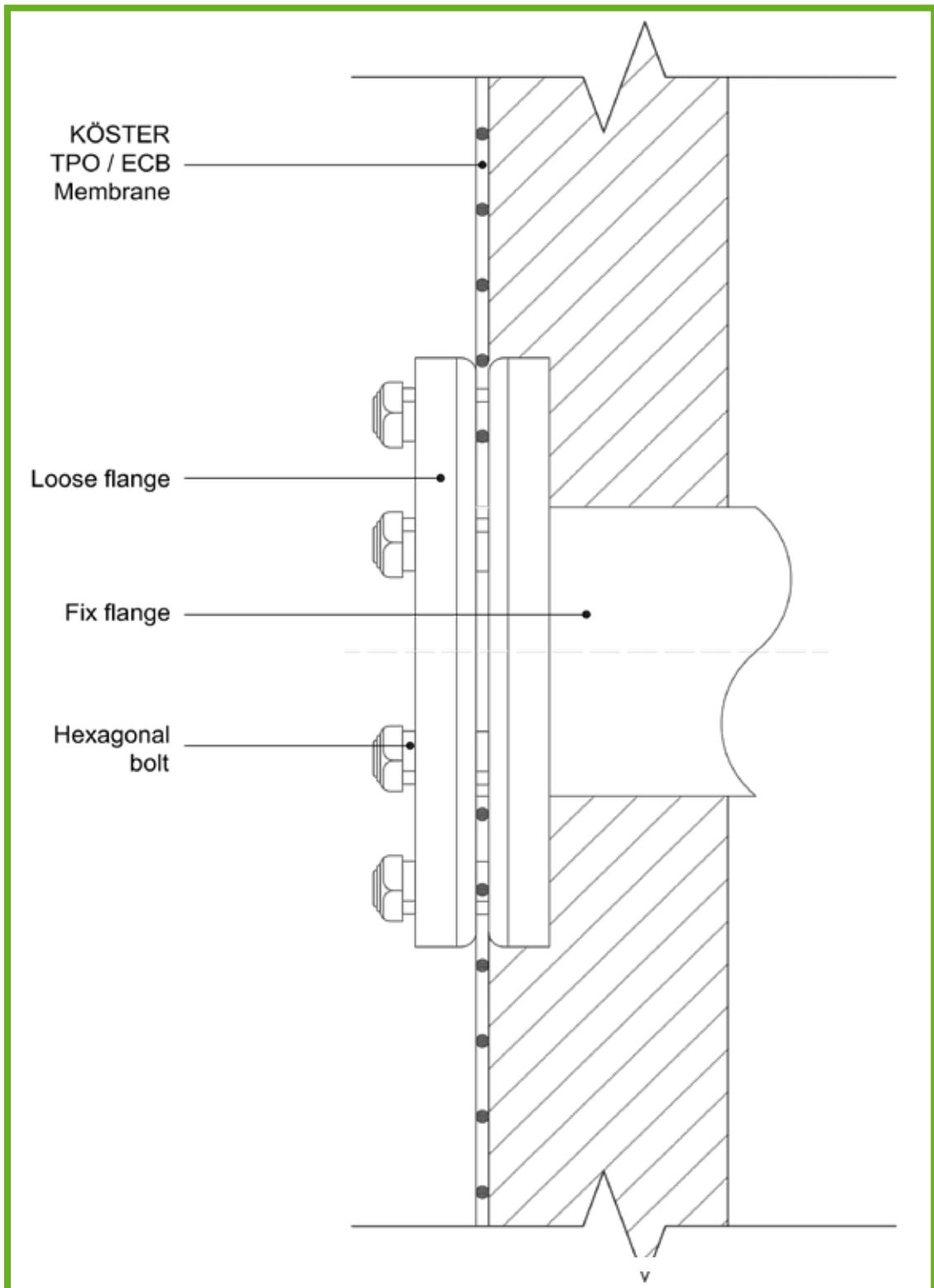

Side view of loose / fixed flange constructions

3.8.3 Junctions to penetrations

Junctions to penetrations should be positioned at least 15 cm above the upper edge of the roof covering and secured at the upper end against running water. For professional waterproofing, the interval between penetrations should be at least 30 cm between each other and other components.

3.8.3.1 Round penetrations





Various KÖSTER junction collars are available for waterproofing round roof penetrations. Information in this regard can be found in the KÖSTER TPO Accessories Brochure. It is recommended to use industrially manufactured moulded parts.

Professional and safe aeration and ventilation in the roof area should be realised with KÖSTER moulded parts.

Junctions to penetrations can also be performed by hand. Use a flange and a collar made of KÖSTER TPO / ECB 2.0 U for pipe penetrations. Secure the upper end of the collar with a stainless steel band or other suitable means.

3.8.3.2. Attachment points, supports, etc.

Attachment points for guardrails, masts, supports and anchorages must be anchored in the roof structure. They should be waterproofed with KÖSTER moulded parts.

	KÖSTER System Roof Vent DN 100	KÖSTER Vent Rain Cover DN 100	KÖSTER Roof Vent with Cap DN 70	KÖSTER Roof Vent with Cap DN 100
				
Nominal width	100	100	70	100
Make	KÖSTER TPO F flange		KÖSTER TPO	Rigid PE flange
Junction to KÖSTER TPO / ECB roofing membrane	Direct welding on KÖSTER TPO		Direct welding on KÖSTER TPO KÖSTER ECB	Using a flange made of KÖSTER TPO 2.0 U / ECB 2.0 U directly welded to the PE flange
Applications	For aeration and ventilation of bathrooms, kitchens, toilets, living rooms, etc. Cold roof aeration	For covering vent rain for System Roof vent DN 100	Cold roof aeration	Cold roof aeration

3.8.3.3. Right-angled penetrations

Junctions to right-angled penetrations, such as chimneys, vents, are implemented in the same way as the wall junctions described in section 3.8.2.1. The corner points should be secured with KÖSTER moulded corner parts. If it is not possible to use moulded parts, corner protection will have to be performed with a round KÖSTER TPO / ECB U piece. The diameter should be at least 50 mm.

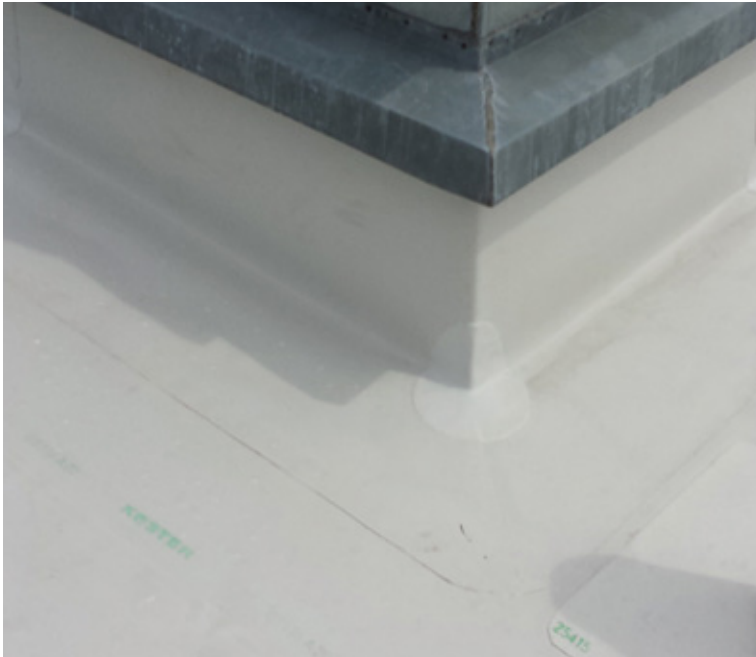

Junctions to right-angled penetrations



3.8.4. Drainage

3.8.4.1. General

Internal drains or external gutters can be used for drainage. Drainage must always be positioned at the lowest point of the gradient.

Drainage planning must be carried out in compliance with the design standard. It must be positioned in such a way that the precipitation water is drained off over a short distance.

3.8.4.2. Storm drains

For roof surfaces with internal drainage, at least one drain and an emergency spillway must be provided, irrespective of the size. Flat roof inlets should be at least 30 cm from rising components or roof structures. Roof

A distinction is made between pressure flow and gravity drainage.

Gravity roof drainage is used in many traditional new buildings and renovation projects whereby there is a requirement for high drainage performance, stability, corrosion and fire resistance combined with minimum maintenance.

Pressurised roof drainage offers a technical solution similar to gravity roof drainage. However, a vacuum is created in the pipe system, which generates a discharge volume that is increased several times over. This means that fewer roof outlets can be used in conjunction with only one pipe run with a smaller diameter than with the gravity flow.

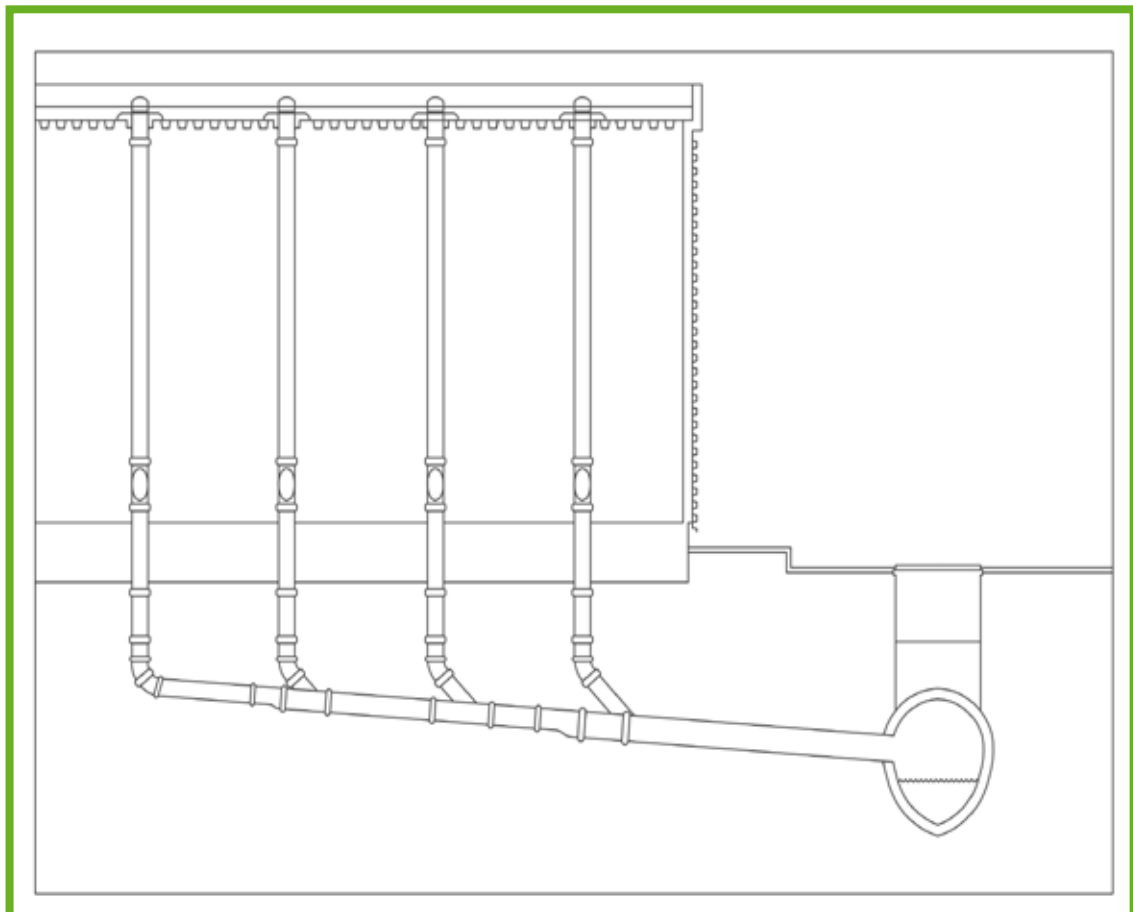

Gravity roof drainage



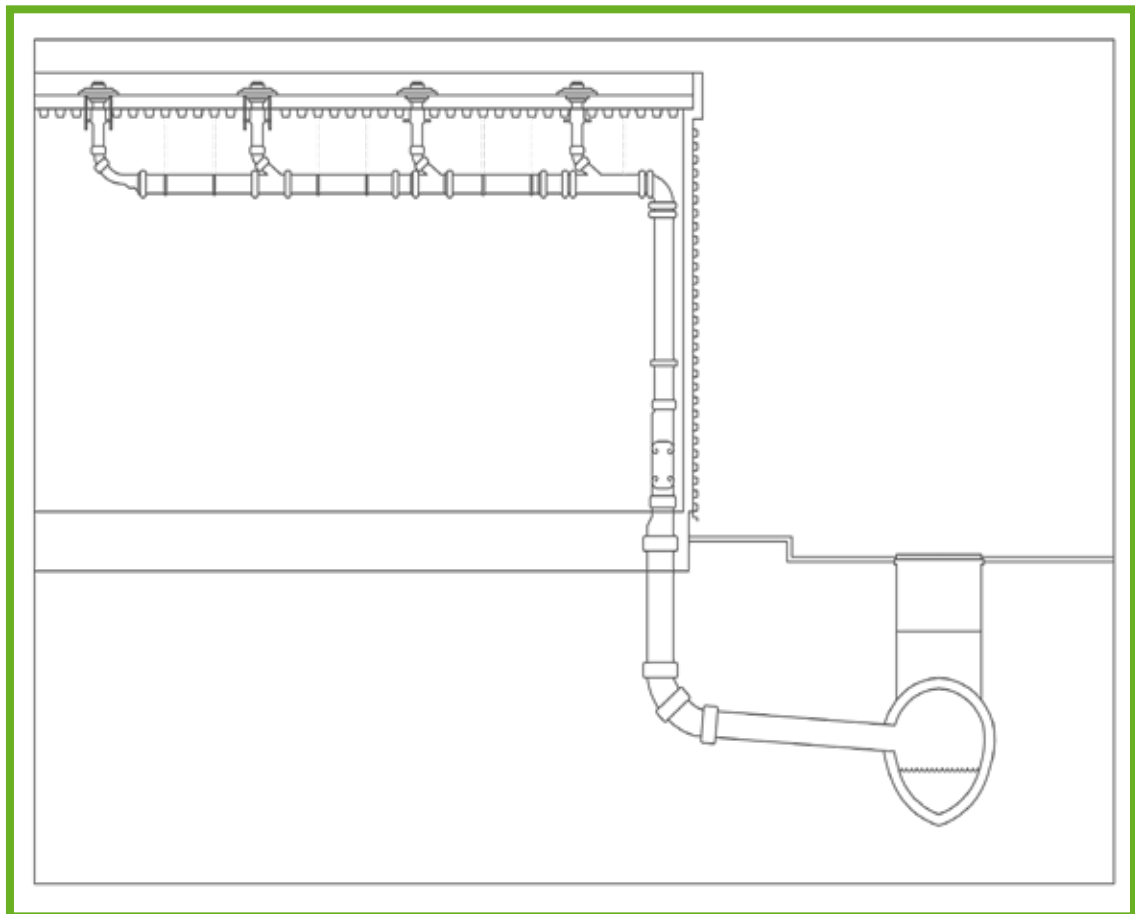

It is possible to produce professional gravity drainage systems with the KÖSTER roof drainage system. It consists of a storm drain for installation in the vapour seal layer or for direct installation in the waterproofing layer and a suitable extension element for insulated roof structures. The roof storm drain and extension element must be fastened to the substructure.

A flange made of KÖSTER TPO / ECB 2.0 U must always be used when using clamping flange storm drains.

KÖSTER drains with sealing lips made of TPO or ECB are used for drainage during renovation work.



Pressurized roof drainage

	KÖSTER Roof Drain T vertical DN 125 / DN 100	KÖSTER Roof Drain T angled DN 100	KÖSTER MORE Roof Drain T damming element	KÖSTER Roof Drain T extension element	KÖSTER Roof Drain with Leaf Trap
					
Nominal Width	125 / 100	100	universal	universal	70 / 100 / 125
Design	KÖSTER TPO F flange	KÖSTER TPO F flange		KÖSTER TPO F flange	TPO/ECB molded part
Junction to KÖSTER TPO/ECB roofing membrane	Direct welding on KÖSTER TPO	Direct welding on KÖSTER TPO		Direct welding on KÖSTER TPO	Direct welding on KÖSTER TPO/ECB
Fields of application	Warm roof Cold roof	Warm roof Cold roof	Damming element for emergency drainage in conjunction with KÖSTER Roof Drain T series	Warm roof in combination with KÖSTER Roof Drain T vertical or angled	Renovation for direct connection to existing downpipes

KÖSTER Roof Drain T vertical 100:												
5	10	15	20	25	30	35	40	45	50	55	60	65
0.6	1.5	2.3	3.3	4.3	5.2	6.1	7.3	8.5	9.4	10.3	11.0	11.7
KÖSTER Roof Drain T vertical 125:												
5	10	15	20	25	30	35	40	45	50	55	60	65
0.7	1.6	2.4	3.3	4.2	5.1	5.9	7.3	8.7	10.1	11.4	12.7	14.0
KÖSTER Roof Drain T angled 100:												
5	10	15	20	25	30	35	40	45	50	55	60	65
0.5	1.2	1.8	2.7	3.6	4.6	5.6	6.7	7.8	9.0	10.2	11.9	13.5

3.8.4.3. Emergency drains/spillways

Emergency drains must always be planned and installed for roofs with internal drainage. The number and size of the emergency drainage depends on the position and size of the roof surface. This must be determined by a drainage assessment.

Emergency drains may not under any circumstances be connected to the sewer system. They can either have a separate drainage line on open ground or drain directly through the attic.

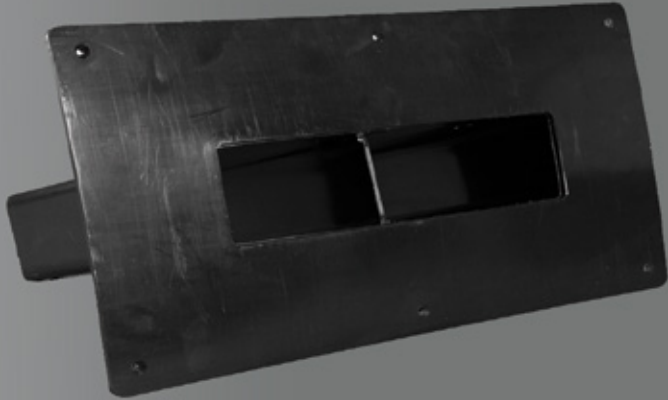

Emergency spillway



Emergency drain



3.8.4.4. Roof gutters

Gutters can be made of a wide variety of materials, such as copper, zinc, stainless steel or PVC. Their dimensions and those of the corresponding downpipes are determined by a drainage assessment. No additional emergency drainage is required for gutters.

Junction of the KÖSTER roofing membrane to the gutter is performed as described in section 3.8.2.4. for junctions to eaves.

Gutters and downpipes made of stainless steel or PVC should be used when using KÖSTER ECB roofing membranes.

If zinc or copper gutters are used for ECB roofing membranes, they must be provided with a protective coating.

When using edge planks to affix the gutter brackets, to ensure safe water drainage these should be 1 cm narrower than the thermal insulation being used.

Gutter



3.8.5. Movement joints

There can be various reasons for movements between the different roof elements. They can be caused by daily or seasonal temperature fluctuations, they can occur slowly or quickly, once, rarely or repeatedly, and can vary in their extent. And they can be run vertically, parallel or at an angle to the waterproofing level. In order to be able to absorb the different forces, the most diverse factors must be taken into account when planning and positioning the movement joints.

Movement joints must be implemented in all layers of the roof structure.

3.8.5.1. Joint type I

Joint type I is usually used on flat roofs. This involves slow, one-off or rare movements of a maximum of 10 mm (e.g. settlement joints or changes in length due to seasonal temperature fluctuations).

With Joint Type I, KÖSTER polymer membranes can be installed directly over the joint. It may be necessary to install a support plate as a drag strip to prevent the sheet from sinking into the joint gap.

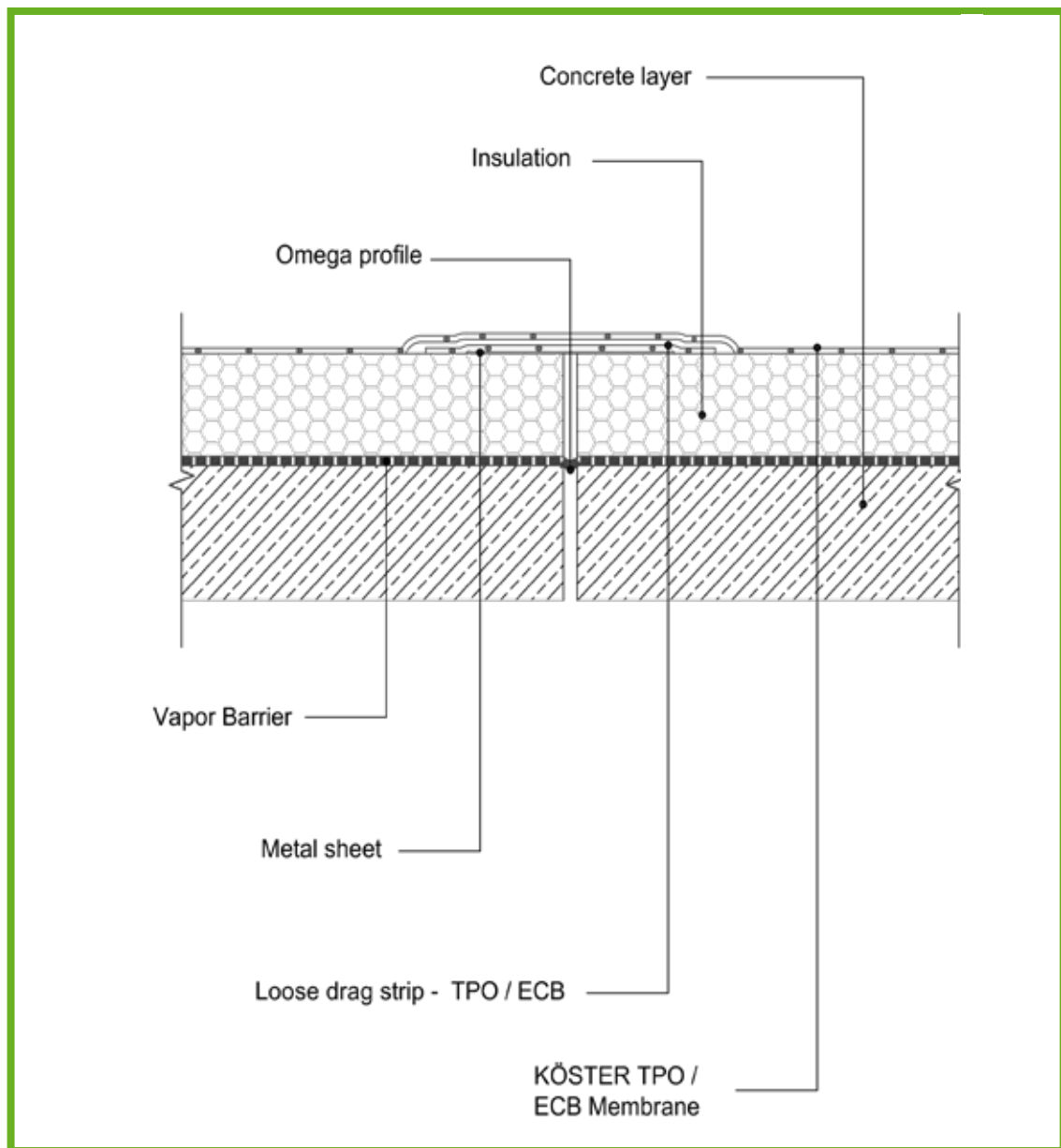

Joint type I

3.8.5.2. Joint type II

Joint type II is required for rapid or frequently repeated movements (e.g. movements due to changing traffic loads or changes in length due to temperature fluctuations during the day) and for movements of more than 10 mm with loosely installed waterproofing. Joints of type II should be lifted out of the waterproofing layer, e.g. by positioning insulation wedges or upstands. The surface parts are to be drained independently of each other.

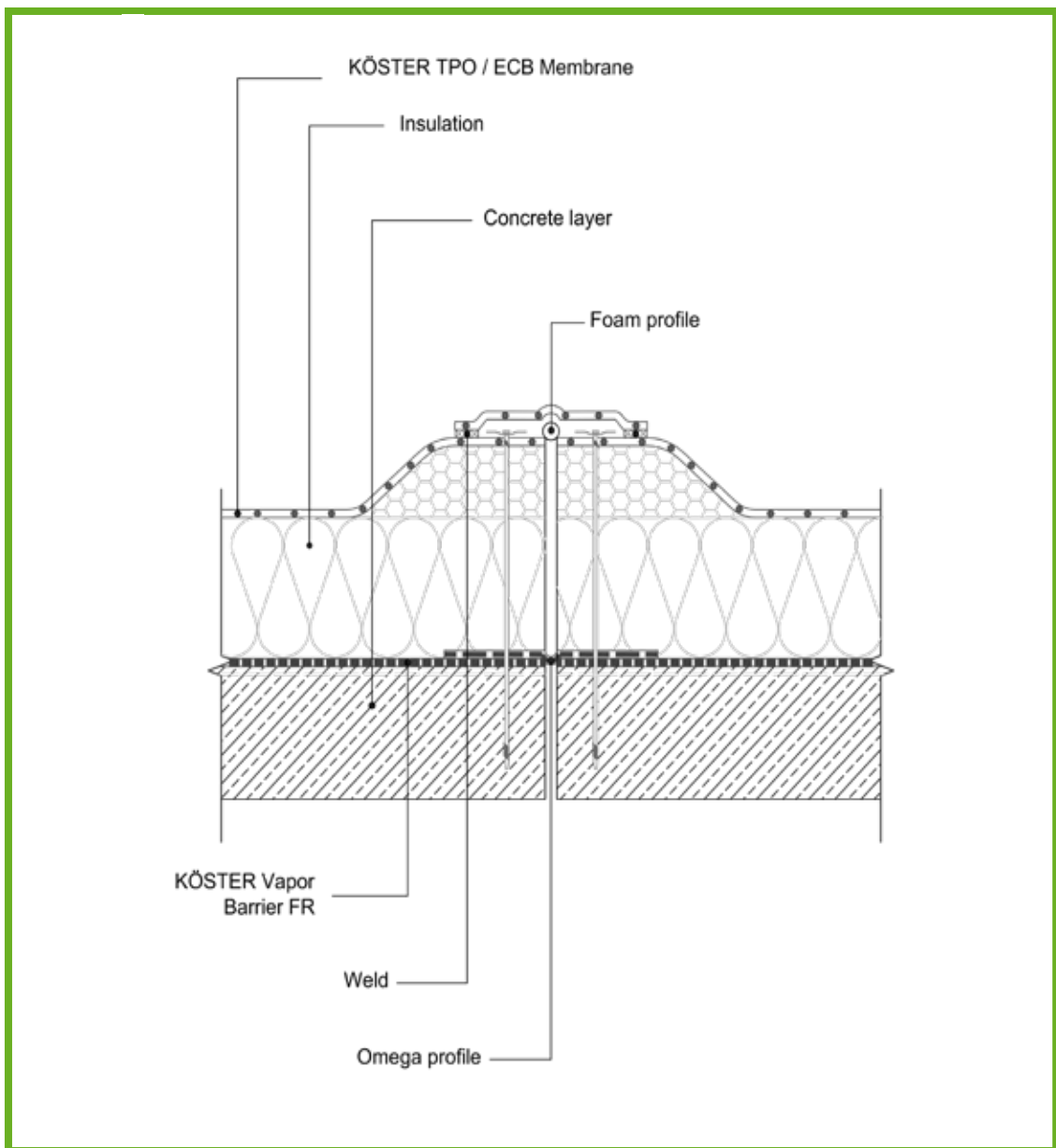

Joint type II

For joint type II, the waterproofing membrane is separated at the joint and mechanically fastened. In the area of the joint, a foam hose or other suitable flexible materials are inserted and covered with a loop-shaped KÖSTER cutting strip.

The vapour barrier must also be installed in the area of the joint in the form of a loop.

Another way to implement a joint type II is to provide an auxiliary construction that separates the two roof areas.

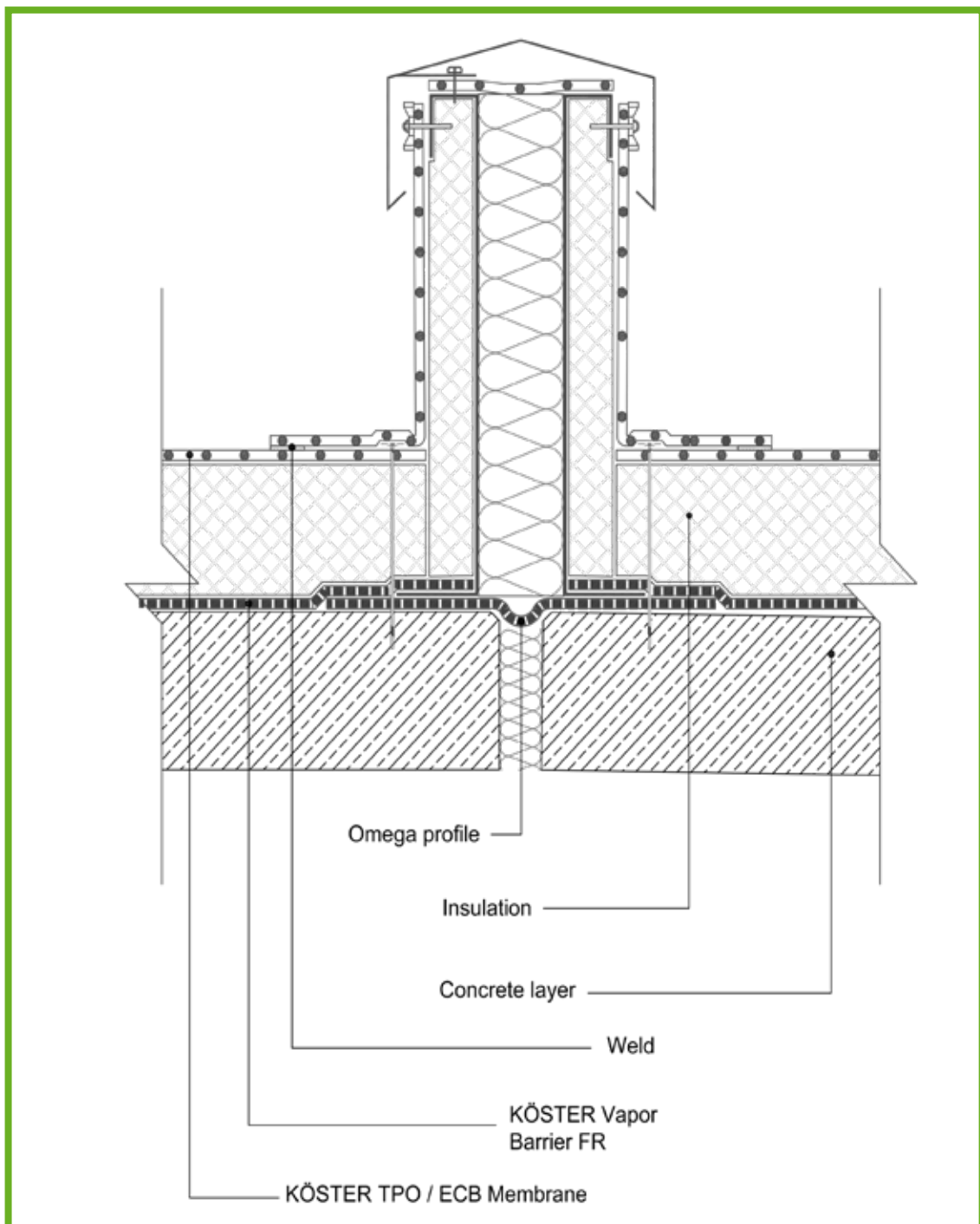

Joint type II

3.8.6. Other

Waterproofing work with KÖSTER roofing and waterproofing membranes may only be carried out during weather conditions that do not have a negative impact on performance. For example, these include temperatures below + 5 °C, moisture, snow, ice or strong wind.

Surfaces between upstands, e.g. channels lined with KÖSTER TPO / ECB membranes or surfaces between rows of windows, should be at least 50 cm wide.

Systems and units should be installed on the waterproofing so that they are easily accessible for care and maintenance, have sufficient space between them and have a minimum distance of 50 cm to the upper edge of the roof covering.

Installed units and systems must not introduce horizontal and vertical forces (compressive loads, shear and stress forces) into the waterproofing in order to prevent damage to the roofing and waterproofing membranes or other components of the roofing layer package.

Anchor points and, if necessary, maintenance routes must be planned for the care, maintenance and repair of roofs.

KÖSTER maintenance route plates or the KÖSTER walkway can be used for the construction and marking of maintenance routes.

When planning and constructing large-area roofs, the regulations of DIN 18234 and the industrial construction guidelines should be observed. These require, among other things, that roofs with roof surfaces larger than 2500 m² must be equipped with fire compartments which hinder the spread of a fire.

4. Terraces / Balconies

Terrace and balcony waterproofing is performed as described above. Flooring must not have a firm bond for waterproofing. Terrace and balcony flooring should be applied on support pads, mortar beds, gravel beds or the like. A separating layer is recommended to protect the KÖSTER membranes from damage. The junction areas of the roofing membranes must be protected.

5. Earth-covered components

KÖSTER TPO and ECB roofing membranes are used for waterproofing earth-covered structures, such as basement ceilings, in accordance with section 3.7.3. Roofs with ballast.

Transitions of ceilings of covered buildings must be pulled down at least 20 cm over the joint between the ceiling and wall and connected to any existing wall waterproofing.

6. Care and Maintenance

Flat roofs with KÖSTER waterproofing should be subject to regular maintenance. The frequency of maintenance depends on the roof pitch and the general stresses on the roof waterproofing.

A roof inspection is recommended once or twice a year, ideally in spring and autumn.

The following work must be carried out:

Maintenance

- Visual inspection of the waterproofing membranes
- Checking junctions and transitions
- Removal of dirt leaves and unwanted plant growth
- Cleaning of roof drains / roof storm drains
- Cleaning of gutters
- Cleaning of aeration and ventilation openings
- Levelling of possible gravel drifts (for roofs with ballast)
- Checking of maintenance joints, such as sealant grouting and the like

An inspection of the flat roof should be carried out every three to four years as part of a roof inspection.

Inspection

- Determining the condition of the waterproofing with a visual inspection
- Checking junctions and transitions
- Checking roof penetration
- Preparing a written log
- Determining any necessary measures

KÖSTER recommends concluding a maintenance contract with the owner/client in order to guarantee continuously functioning waterproofing made of KÖSTER TPO / ECB roofing membranes.

7. Renovations

7.1. General

Renovation of flat roofs will eventually become necessary due to strong climatic loads, natural aging of the products, or new energy requirements.

Renovation work should be carefully thought through and planned. Due to the many factors to be considered, such as the current state of the existing roof, or if a change in the use of the roof or building is intended, there should or must be a general statement on renovation work with respect to an increase in the insulation values of the roof structure.

Before determining the scope of the renovation, a roof opening at one or more points must be used to check whether the existing roof structure is still functional.

- Is there a vapour seal, or is it still functional?
- Is the insulation dry and does it meet the requirements?
- Are there any thermal bridges in the roof structure?
- Is the roof layer package still stable with respect to wind suction forces, e.g. by sufficient adhesion, or have the mechanical fastening elements corroded?

The following points must also be checked:

- Does the roof have a sufficient gradient?
- Does the existing drainage system meet the requirements?
- Are there enough emergency drains for internally draining roof surfaces?
- Is the insulation thickness sufficient?
- Is the load-bearing capacity of the roof structure still sufficient?
- Are the junction heights sufficient?
- Are there any movement joints?
- Do built-in parts, such as downpipes or skylight domes have to be replaced or supplemented?

A renovation plan can be prepared after evaluating all these points.

7.2. Renovation without removal of the old roof

If the entire roof structure is still intact and meets the requirements, renovation can be carried out directly on the existing waterproofing layer without removal of the roof layer package.

If built-in parts are being replaced or are additionally required, they must be professionally installed in the roof layer

package, including junction to the vapour seal. All installation instructions for waterproofing with KÖSTER roofing membranes must be observed.

7.2.1. Old bitumen roof

KÖSTER roofing membranes are bitumen-compatible and can be installed directly on old bitumen roof waterproofing.

If the positioning of the roof structure is stable, fleece-laminated KÖSTER TPO and ECB roofing membranes can be adhered with KÖSTER PUR Membrane Adhesive or KÖSTER 2C PUR Membrane Adhesive.

Mechanical fastening of KÖSTER F roofing membranes or KÖSTER roofing membranes without fleece lamination is also possible. This option particularly makes sense if the old waterproofing is no longer stable. If non-laminated KÖSTER roofing membranes are to be used, polyester fleece $300 \leq \text{g/m}^2$ must be installed as a separating layer.

KÖSTER TPO SK (FR) is also suitable for direct installation on bitumen waterproofing. If the self-adhesive KÖSTER membrane is to be used, the roof surface has to be cleaned well and pre-treated with KÖSTER TPO SK-Primer.

It should be noted that light-colored KÖSTER TPO roofing membranes can easily discolor if installed directly on bitumen waterproofing. These discolorations have no influence on the quality and durability of KÖSTER TPO roofing and waterproofing membranes.

Roofs with ballast for position stability are dealt with as per section 3.7.3. A separating layer of polyester fleece $\leq 300 \text{ g/m}^2$ must be provided between the old roof and the new waterproofing layer.

7.2.2. Old plastic roofs

KÖSTER TPO and ECB roofing membranes can be installed directly on old rubber or plastic membranes and liquid membrane roofs due to their material compatibility with all conventional waterproofing membranes.

In order to avoid adverse effects on the roof structure, the existing waterproofing must be loosened at all junctions and transitions, and if necessary also in the surface.

For mechanically fixed roofs subject to weathering, a fire protection layer of glass mat at least 120 g/m^2 must be provided between the old plastic roof and the KÖSTER roofing membrane.

KÖSTER roofing membranes must be mechanically fastened in accordance with EN 1991-1-4.

For loose installation with ballast, the glass fleece separating layer is not required.

7.3. Renovation with removal of the waterproofing layers

If the old roof waterproofing layer is no longer stable, if negative effects on the new waterproofing with KÖSTER membranes are to be expected, or if the insulation material is partially soaked through, this old layer must be removed.

Subsequently, the KÖSTER waterproofing layer can be installed as described in the sections above. Moist insulation must be replaced.

If KÖSTER TPO F / TPO SK roofing membranes are to be adhered to existing insulation, it must be fastened in a windproof manner.

7.4. Renovation with additional insulation

Flat roof renovation with additional insulation of a dry roof structure with a functional vapour seal can usually be without a detailed physical calculation or evaluation. The old waterproofing layer can be retained in this case. The requirements for stability of the roof layer package must be observed.

The thickness of the additional insulation should be at least 5 cm, irrespective of the building structural assessment.

In the event of an existing damp roof structure, renovation with additional insulation must be precisely analysed and thorough knowledge of the building's structure is required. The widespread view that damp insulation in a flat roof dries out within a short time is not tenable. The drying process takes many years and is determined by the thermal transfer resistance of the thermal insulation and especially by the diffusion resistance of the new waterproofing.

In most cases, the drying out of the roof is significantly altered by the application of additional insulation and new waterproofing.

If the old waterproofing layer is perforated, the moisture is transferred to the new additional insulation. The drying process of the total moisture of both insulation layers takes many years and, after the moisture transfer, runs its course at the level of a roof structure without additional insulation.

However, the expected drying time cannot be calculated in terms of a building's structural assessment.

One KÖSTER Roof Vent DN 70 per 25 m² of roof surface has proven itself in practice.

In the case of new, relatively diffusion-resistant waterproofing or moisture-sensitive additional insulation, perforation of the old waterproofing

should be avoided. Although drying out of the existing insulation is reduced, the new structure is not adversely affected by moisture displacement.

The additional insulation and the new waterproofing can be selected much more freely. They only have a minor influence on drying behaviour and serviceability.

Renovation of a damp roof structure without replacing the wet insulation should only be undertaken in exceptional cases!

The prerequisite is a functioning vapour seal, as otherwise the moisture from the insulating material can also seep inwards and cause damage to the building over a long period of time.

7.5. Complete renovation

If damage to the roof structure is extensive and, for example, if the roof drainage or other built-in parts have to be renovated, it is more economical to carry out a complete renovation. All of the waterproofing and the thermal insulation layer will be replaced during this renovation.

The waterproofing methods described in this manual are to be applied for the renovation.

8. Information for working with KÖSTER TPO / ECB

8.1. Tools

The basic equipment includes a manual welding unit with a temperature window of 350 - 620 °C and a 40 mm wide slot nozzle, scissors, a 40 mm wide silicone roller, a knife, a seam tester, a wire brush, a folding rule and, for larger roof surfaces, an automatic roofing membrane welding machine.

A digital temperature measuring device is recommended if you are using welding devices without digital display of the welding temperature.

8.2. Welding

KÖSTER TPO roofing membranes and KÖSTER ECB roofing membranes can only be welded with hot air. The seams can be welded in the normal course of construction without any additional effort. Chemical activation of the seam or the use of prep nozzles is not necessary.

The welding temperature can be 350 °C to 620 °C. The setting depends on the material thickness and the working conditions.

For welding KÖSTER moulded parts, the welding temperature should be approx. 400 °C - 450 °C.

Depending on the material thickness, the

moving speed of automatic welding machines varies between 1.5 m/min and 5 m/min.

At the beginning of the daily work and in strongly changing weather conditions, test welds must be carried out in order to determine the required welding parameters, by welding two KÖSTER TPO / ECB strips. After the weld test sample has cooled to the ambient temperature, cut out an approx. 5 cm wide strip and perform a peel test. It must not be possible to separate the two strips manually. Failure of the material outside the joining seam is permissible.

KÖSTER BAUCHEMIE AG recommends storing the welding test samples for documentation purposes.

After ≥ 24 hours, a seam inspection of all welds must be carried out with the KÖSTER weld seam tester.

8.3. Weathered TPO and ECB roofing membranes

KÖSTER TPO roofing and waterproofing membranes can be welded homogeneously over their entire service life.

When welding with older TPO or ECB roofing membranes, a test weld will show whether pre-treatment is required. If the welding result is not satisfactory, patina and dirt must be mechanically removed.

For cleaning the welding surfaces of older or heavily soiled TPO sheets, it is recommended to use a burnishing machine, an angle grinder with a wire brush or sandpaper attachment.

8.4. General comment

Thermoplastic materials made of polyolefins are subject to changes in all directions; they expand when hot and contract when cold. This property has no effect on the quality and service life of the polymer membranes. KÖSTER TPO / ECB roofing and waterproofing membranes are free of plasticisers and are flexible at low temperatures up to at least -50 °C. This ensures a long service life with consistent quality.

Experience has shown that the formation of irregularities decreases over time.

9. Accessories

A wide variety of accessories and materials are available for professional waterproofing with KÖSTER TPO / ECB roofing membranes.

For more information, please refer to the current price list and the accessories brochure.



10. Service forms
10.1 Wind zone map of Germany

*Wind zone of the Federal Republic of Germany
In accordance with DIN EN 1991-1-4/NA:2010:12*

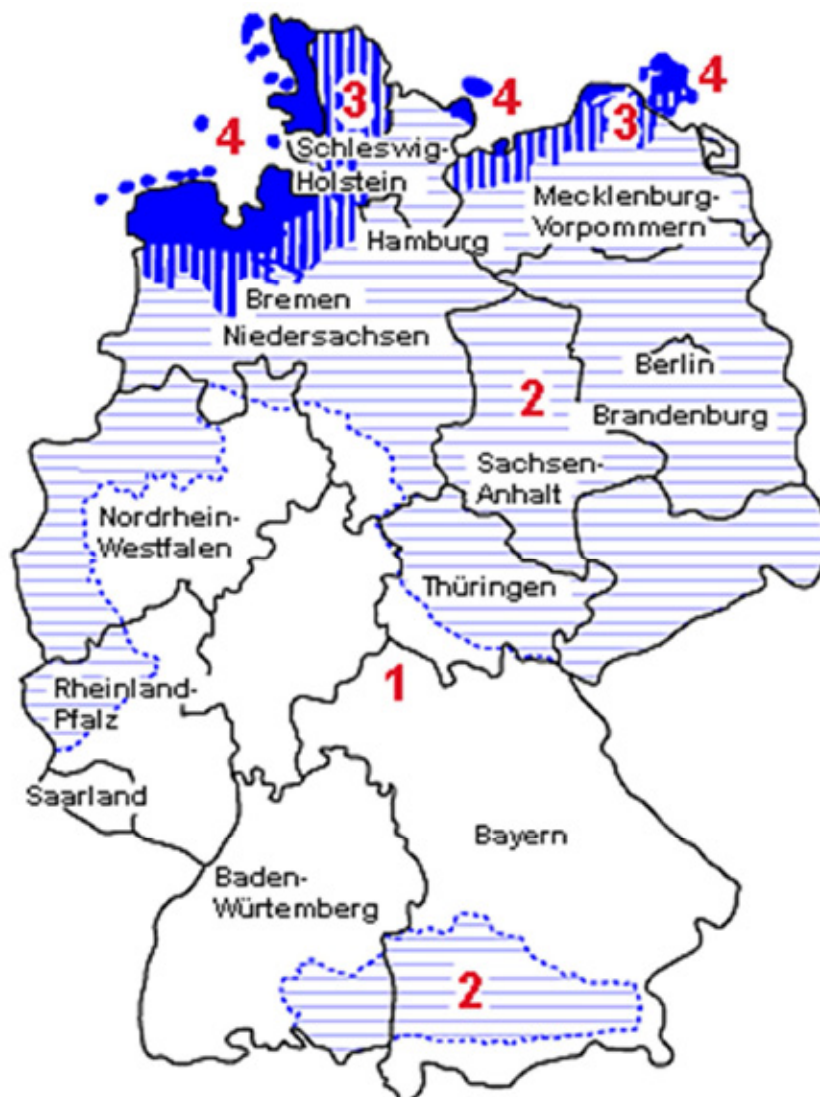

10.2 Site categories

Site categories

In accordance with DIN EN 1991-1-4/NA:2010:12

Site category I

Open lake; lakes with at least 5 km of open area in wind direction; smooth, flat land without obstacles

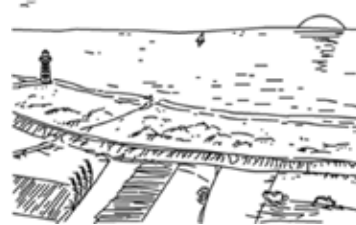

Site category II

Site with hedges, individual farms, houses or trees, e.g. an agricultural area



Site category III

Suburbs, industrial or commercial areas; forests



Site category IV

Urban areas where at least 15% of the area is covered with buildings with an average height exceeding 15 m

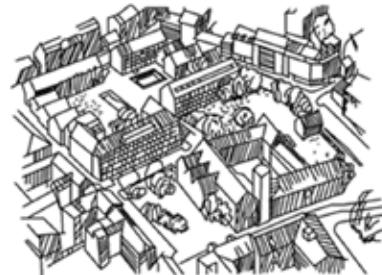

Mixed profile coast

Describes the relationships in a transition area between site category I and II

Mixed profile inland

Describes the relationships in a transition area between site category II and III

10.3 Wind load calculations

KÖSTER BAUCHEMIE AG provides wind load calculations for its customers on request as a free service.

Page 1

WINDLASTANFRAGE

Datenaufnahmeblatt zur Windlastberechnung nach:

Euro Code(EC): EN 1991-1-4:2005 (DIN EN 1991-1-4/NA:2010-12)

.....

Kontaktdaten:

Name: Vorname:
Firma: Straße:
Postleitzahl: Ort:
Land:
Telefon: Telefax:
E-Mail:

Bauvorhaben:

Bauherr:
Bauvorhaben: Straße:
Postleitzahl: Ort:
Land:
Neubau: Altbau:
Teilfläche: Erweiterung:

Geometrie des Gebäudes:

Pläne/Skizzen vollständig bemaßt beigelegt: ja: nein:
Länge: Breite: Höhe: Dachneigung:*
Dachform: Innenentwässerung: Außenentwässerung:
Höhe Attika:m
(Bei der Angabe ist der kleinste Wert zwischen Oberfläche und Oberkante Attika maßgebend)

Lage des Gebäudes *: Geländekategorie: oder Mischprofil: I/II II/III
Windzone:

Baukörper *:

- Geschlossenes Gebäude (Öffnungsanteil Außenwände <1% und annähernd gleich verteilt)
 Öffnungsanteile mindestens einer Außenwand $\geq 1\%$ und $\leq 30\%$
 Offenes Gebäude (Öffnungsanteile mind. einer Außenwand > 30% Skizze mit Lage der Öffnungen beifügen!)

*Bitte beachten Sie die Angaben in den Beiblättern zum Formular zur Windlastberechnung.

Page 2

KÖSTER TPO 2,0
 KÖSTER TPO 2,0 F

PUR/PIR

Sonstiges

..... Dicke: mm

..... Blechdicke:mm

Obergurtbreite:mm

..... lachig

..... er:

..... tiges:

..... m² (bei Begrünung trocken)

Ort und Datum

Unterschrift

Voraussetzung zur Erstellung eines Nachweises nach EN 1991-1-4:2005 (DIN EN 1991-1-4/NA:2010-12) ist das vollständig ausgefüllte Formblatt der KÖSTER Bauchemie AG.
Die Angaben sind die Grundlage der Berechnung.

Bitte ausgefüllt und unterschrieben zurück an die KÖSTER Bauchemie AG:
per E-Mail an: info@koester.eu per FAX: +49 (0) 4941 970 9571

10.5 Flat roof renovation checklist

Upon request, KÖSTER BAUCHEMIE AG supports its customers with this checklist during flat roof renovation.

Seite 1

Checkliste Flachdach Sanierung

Datum: 01.01.2017

Bauvorhaben	
Straße	
Ort	

Auftraggeber	
Telefon	E-Mail
Straße	
Ort	

Gebäudenutzung:		Baujahr	
Dachneigung	°	Bemerkungen	
Dachform	Flachdach	<input type="checkbox"/>	
	Pultdach	<input type="checkbox"/>	
	Sheddach	<input type="checkbox"/>	
	Satteldach	<input type="checkbox"/>	
	Balkon/Terrasse	<input type="checkbox"/>	
	Erdüberschüttetes Bauteil	<input type="checkbox"/>	
Dachaufbau	Sonstiges	<input type="checkbox"/>	
	Unbelüftet (Warmdach)	<input type="checkbox"/>	
Gebäudehöhe	Belüftet (Kaldach)	<input type="checkbox"/>	
	m		
Attika	<input type="checkbox"/>	Höhe:	m

Altdach	Alter der Abdichtung		Bemerkungen
Bitumen	Anzahl der Lagen		
	PVC	<input type="checkbox"/>	
	ECB	<input type="checkbox"/>	
	TPO/FPO	<input type="checkbox"/>	
	EPDM	<input type="checkbox"/>	
	PIB	<input type="checkbox"/>	
Kunststoffdachbahn	Sonstiges	<input type="checkbox"/>	
	Flüßigkunststoff	<input type="checkbox"/>	
Sonstiges	<input type="checkbox"/>		

Oberflächenbeschaffenheit				
Risse	<input type="checkbox"/>	Verschmutzung	<input type="checkbox"/>	
Falten	<input type="checkbox"/>	Bewuchs	<input type="checkbox"/>	
Blasen	<input type="checkbox"/>	Algen/Flechten/Moos	<input type="checkbox"/>	
Aufラスト	Kies	<input type="checkbox"/>	Durchschnittliche Dicke ca. cm	
	Plattenbelag	<input type="checkbox"/>		
	Gründach	Extensiv		<input type="checkbox"/>
		Intensiv		<input type="checkbox"/>

Dachöffnung	ja <input type="checkbox"/>	nein <input type="checkbox"/>	
-------------	-----------------------------	-------------------------------	--

Unterkonstruktion		Tragfähig?		Bemerkungen
Stahltrapezblech	<input type="checkbox"/>	<input type="checkbox"/>		
Beton	<input type="checkbox"/>	<input type="checkbox"/>		
Holz	<input type="checkbox"/>	<input type="checkbox"/>		
Sonstiges	<input type="checkbox"/>	<input type="checkbox"/>		

Dampfsperre	ja <input type="checkbox"/>	nein <input checked="" type="checkbox"/>	Bemerkungen
Brandlastarme DS	<input type="checkbox"/>	<input checked="" type="checkbox"/>	
Bituminöse DS	<input type="checkbox"/>		
PE - Folie	<input type="checkbox"/>		
Sonstiges	<input type="checkbox"/>		
Funktionstüchtig	ja <input type="checkbox"/>	nein <input type="checkbox"/>	

Dämmung		Dicke	WLG	Durchfeuchtet?	Bemerkungen
EPS	<input type="checkbox"/>	mm		ja <input type="checkbox"/> nein <input type="checkbox"/>	
Mineralwolle	<input type="checkbox"/>	mm		ja <input type="checkbox"/> nein <input type="checkbox"/>	
PUR/PIR	<input type="checkbox"/>	mm		ja <input type="checkbox"/> nein <input type="checkbox"/>	
Schaumglas	<input type="checkbox"/>	mm		ja <input type="checkbox"/> nein <input type="checkbox"/>	
Sonstiges	<input type="checkbox"/>	mm		ja <input type="checkbox"/> nein <input type="checkbox"/>	

1,5 mm	<input type="checkbox"/>	<input checked="" type="checkbox"/>	<input checked="" type="checkbox"/>	<input checked="" type="checkbox"/>
1,8 mm	<input type="checkbox"/>	<input checked="" type="checkbox"/>	<input checked="" type="checkbox"/>	<input checked="" type="checkbox"/>
2,0 mm	<input type="checkbox"/>	<input checked="" type="checkbox"/>	<input checked="" type="checkbox"/>	<input checked="" type="checkbox"/>
KÖSTER ECB ECB E				

Seite 2

Funktionsfähig?			
ja	<input type="checkbox"/>	nein	<input type="checkbox"/>
ja	<input type="checkbox"/>	nein	<input type="checkbox"/>
ja	<input type="checkbox"/>	nein	<input type="checkbox"/>
ja	<input type="checkbox"/>	nein	<input type="checkbox"/>

Funktionsfähig?		Bemerkung
ja	<input type="checkbox"/>	
nein	<input type="checkbox"/>	
ja	<input type="checkbox"/>	
nein	<input type="checkbox"/>	

Bemerkung	
<input type="checkbox"/>	
<input type="checkbox"/>	

Höhe fachgerecht?			
ja	<input type="checkbox"/>	nein	<input type="checkbox"/>
ja	<input type="checkbox"/>	nein	<input type="checkbox"/>

Abmessung			
ja	<input type="checkbox"/>	nein	<input type="checkbox"/>
ja	<input type="checkbox"/>	nein	<input type="checkbox"/>

Höhe fachgerecht?			
ja	<input type="checkbox"/>	nein	<input type="checkbox"/>
ja	<input type="checkbox"/>	nein	<input type="checkbox"/>
ja	<input type="checkbox"/>	nein	<input type="checkbox"/>

Abmessung			
ja	<input type="checkbox"/>	nein	<input type="checkbox"/>
ja	<input type="checkbox"/>	nein	<input type="checkbox"/>

Funktionsfähig?		Bemerkung
ja	<input type="checkbox"/>	
nein	<input type="checkbox"/>	

11. Tender documents

KÖSTER BAUCHEMIE AG helps architects and planners with preparation of tenders and service specifications

You will find tender documents in standard formats at www.ausschreiben.de.

You can directly access the KÖSTER tender documents using the QR-Code:



<http://www.ausschreiben.de/katalog/koester/position/4577>

12. Legal Notice

The information in this technical manual is based on the generally applicable state of the art and on the standards and guidelines necessary for implementing roof waterproofing work.

Compliance with the information in this manual and with the KÖSTER TPO installation instructions is a prerequisite for the KÖSTER BAUCHEMIE AG warranty.

Sources:

Flat roof guideline of the ZVDH

DIN 18195

DIN 18531

DIN 1991-1-4



Service you can depend on

With our service and distribution network in many countries world-wide we can offer you professional advice and technical support immediately and on the spot. Your required waterproofing materials can be delivered promptly and will protect your property efficiently and lastingly.



For further information, please contact:

KÖSTER
Waterproofing Systems



DEUTSCHE
BAUCHEMIE



KÖSTER BAUCHEMIE AG | Dieselstraße 1–10 | D-26607 Aurich | Germany
Phone: +49 (4941) 9709-0 | Fax: +49 (4941) 9709-40 | info@koster.eu | www.koster.eu